

2023

HIGH QUALITY MOTORCYCLE PARTS





Andrea Migno, Snipers Team Moto 3 rider

TECHNICAL PARTNERSHIP

Moto3 World Championship

SNIPERS
TEAM

WorldSBK

HRC OFFICIAL
SPONSOR

  **BMW MOTORRAD**
WorldSBK Team



MotoE World Championship



BSB British Superbike

PBM

  **BMW MOTORRAD**
MOTORSPORT

Endurance World
Championship

  **BMW MOTORRAD**
World Endurance Team

WorldSSP

ALTHEA
Racing

We are the official supplier of important teams within the world of international competitions. Race tracks are the best test bench for our high performance components.

Siamo fornitori ufficiali di importanti Team nel mondo delle competizioni internazionali. I circuiti di gara sono il miglior banco prova per i nostri componenti ad alte prestazioni.

INDEX - INDICE

| | |
|--------------------------------------------------------------------------|----|
| ABOUT US - CHI SIAMO | 7 |
| REARSETS - PEDANE | 8 |
| ENGINE PROTECTIONS - PROTEZIONI MOTORE | 28 |
| DASHBOARD PROTECTIONS - PROTEZIONI STRUMENTAZIONE | 44 |
| TOP TRIPLE CLAMP - PIASTRE DI STERZO SUPERIORI | 48 |
| LEVERS - LEVE | 52 |
| FULL CLUTCH LEVER - LEVE FRIZIONE COMPLETE | 64 |
| BRAKE LEVER WITH REMOTE ADJUSTER - LEVE FRENO CON REGISTRO REMOTO | 66 |
| REMOTE ADJUSTER - REGISTRO REMOTO | 67 |
| LEVER PROTECTIONS - PROTEZIONE LEVE | 70 |
| HANDLEBARS - SEMIMANUBRI | 74 |
| CHAIN ADJUSTER - TENDICATENA | 78 |
| OIL TANK 8 ml - SEBATOI OLIO 8 ml | 80 |
| SWING ARMS SPOOL - SUPPORTI CAVALLETTO | 81 |
| MIRROR BLOCKS - TAPPI SPECCHIETTO | 82 |
| OIL CAPS - TAPPI OLIO | 83 |
| TANK CAPS - TAPPO SERBATOIO | 84 |
| CHAIN PROTECTION - PARACATENA | 85 |
| MODELS - MODELLI | 86 |

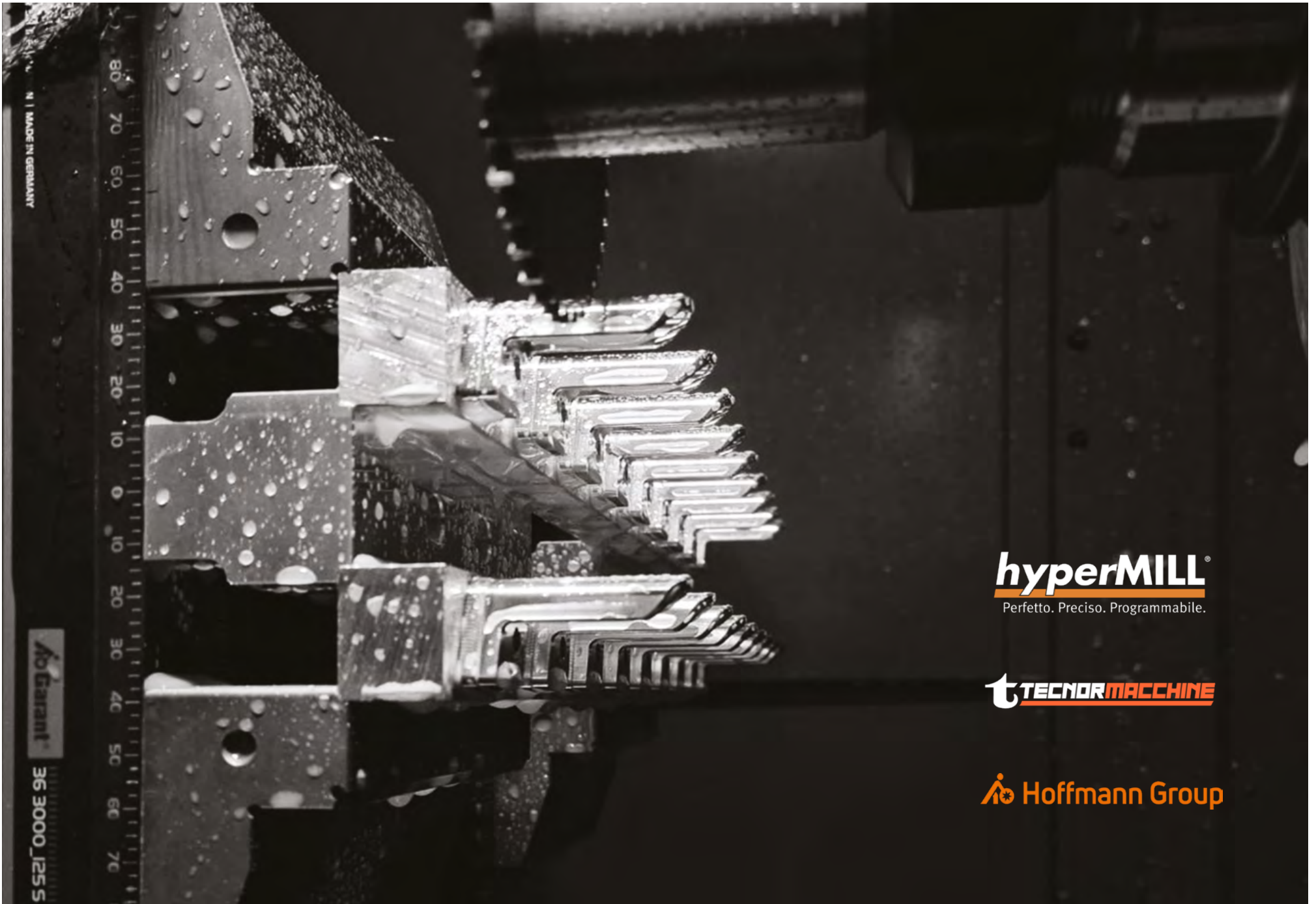

MADE IN GERMANY

AvGarant

S 521 000E 9E 36 3000 125 S

hyperMILL®
Perfetto. Preciso. Programmabile.

t TECNORMACCHINE

Hoffmann Group



Design Progettazione

Every single detail of our products is the result of an accurate engineering design process, we develop the racing components that weigh no one gram more than necessary. The beauty of the lightness became tangible throughout the design, perspective and lines have been drawn to push over the performance.

Anche il più piccolo dettaglio dei nostri prodotti è il risultato di un accurato processo di progettazione, sviluppiamo componenti da competizione che non pesano un grammo più del necessario. La bellezza della leggerezza è resa tangibile attraverso il design, prospettiva e linee sono tracciate per andare oltre le prestazioni.



Production Realizzazione

We use the best technologies to produce the racing accessories with maximum care possible. By making a constant quality-oriented investments, by using of CNC machines and the best titanium, aluminum and steel alloys, we make high technology accessories to obtain the best performance during the race competitions.

Usiamo le migliori tecnologie per produrre accessori per moto in maniera accurata. Attraverso investimenti sulla qualità, l'uso di macchine a controllo numerico e le migliori leghe di titanio, alluminio e acciaio, produciamo accessori altamente performanti, in modo da ottenere il massimo delle prestazioni durante le competizioni motociclistiche.



Assistance Assistenza

We are ever ready to assist our customers and to provide them with the best solutions to optimize their mode to run the bike. We are able to develop new racing accessories and improve our products based on the reciprocal feedback. Our aftersales staff can solve any problems with maximum care and efficiency possible.

Siamo sempre pronti ad aiutare i nostri clienti per dargli le migliori soluzioni in grado di ottimizzare il loro modo di correre in moto. Siamo in grado di sviluppare nuovi accessori da corsa e migliorare i nostri prodotti attraverso il feedback costante tra noi ed i nostri clienti. Il nostro personale post-vendita è in grado di risolvere tutti i problemi con la massima cura ed efficienza possibile.



Tradition Tradizione

The Italian culture leads us to appreciate the beauty that is transmitted in all our products. We produce our accessories in Italy with the respect of Italian tradition. The history teaches us to create new items using the ingredients that brought Italy a fame in the field of race competitions.

La cultura italiana ci ha dato il senso del bello che noi trasmettiamo a tutti i nostri prodotti. Produciamo i nostri accessori in Italia con il rispetto della tradizione italiana, la storia ci insegna a fare nuovi oggetti, con tutti gli ingredienti che hanno reso l'Italia famosa nel mondo delle competizioni.

REARSETS - PEDANE

REARSETS TECHNICAL FEATURES

- High performance aluminum
- Double ball bearings
- Racing footrest with high grip
- Wide adjustment of the footrest position
- Hard anodic oxidation treatment
- Shift lever adjustable
- Break point of the footrest
- Non-slip rubber tip

REARSETS CARATTERISTICHE TECNICHE

- Alluminio ad alte prestazioni
- Doppie cuscinetti a sfera
- Poggiapiedi racing ad alto grip
- Regolazione della posizione del poggiapiedi
- Trattamento di ossidazione anodica dura
- Leva del cambio regolabile
- Punto di rottura del poggiapiedi
- Punta in gomma antiscivolo

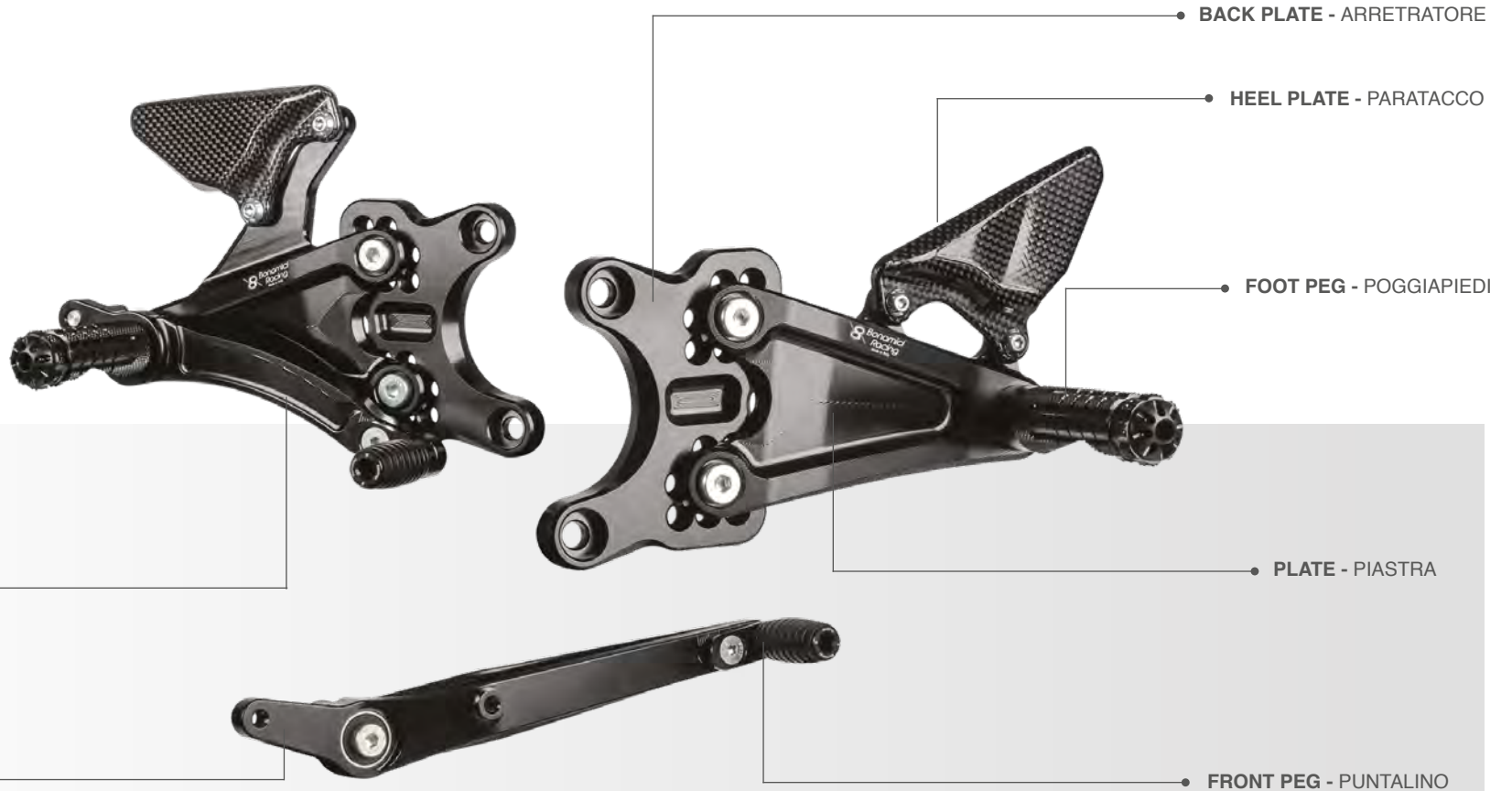

BRAKE LEVER - LEVA FRENO

GEAR LEVER - LEVA CAMBIO

Bonamici Racing designs and manufactures rearsets for most of the models of sport-bikes on the market since 1994.

Made from billet high-strength aluminum alloys with CNC technology, Bonamici Racing rearsets have many peculiarities, among them there is the use of ball bearings to completely eliminate friction on the levers, spring for the assisted return of the rear brake lever and the possibility of adjustment in different positions.

All the rearsets in our catalog are anodized in black to have greater mechanical resistance and greater resistance to the chemical agents, in addition we have the possibility of customizing the platforms in many ways.

Bonamici Racing progetta e realizza pedane poggiapiedi per la maggior parte di modelli di moto sportive presenti sul mercato dal 1994.

Realizzate dal pieno in leghe di alluminio ad alta resistenza con tecnologia CNC, le pedane Bonamici Racing hanno molte peculiarità, tra queste vi è l'uso di cuscinetti a sfera per eliminare completamente gli attriti sui leveraggi, molla per il ritorno assistito della leva freno posteriore e la possibilità di regolazione in differenti posizioni.

Tutte le pedane presenti in catalogo sono anodizzate nel colore nero per avere una maggiore resistenza meccanica ed agli agenti chimici, inoltre c'è la possibilità di personalizzare le pedane in tanti modi.



NOTES - NOTE

A: without brake and gear levers, the original one to be used - senza leve cambio e freno, si utilizzano quelle originali
B: remove the sprocket protection - rimuovere il carter copripignone
C: remove the plastic protection from the exhaust - rimuovere la protezione in plastica sullo scarico
D: remove the lateral stand - rimuovere il cavalletto laterale
D1: remove the lateral stand (only for reverse shifting) - rimuovere il cavalletto laterale (solo per cambio rovesciato)
E: it is not possible to mount the passenger rearsets - non è possibile rimontare le pedane del passeggero
F: includes the gear selector - include il selettore cambio
G: includes the rear oil tank - include il serbatoio olio posteriore
H: includes the warm carbon protection - include il paracalore in carbonio
I: includes carbon heel plates - include i paratacchi in carbonio
L: it is not possible to mount the hydrostop - non è possibile montare l'hydrostop
M: it need to modify the original fairing - occorre modificare le carene originali

N: can use in normal shifting mode - può funzionare con il cambio normale
O: it need to change the rear brake tube - è necessario sostituire il tubo freno posteriore
P: it's possible to mount carbon heel plates accessories - è possibile montare i paratacchi in carbonio come accessorio
R: can use in reverse shifting mode - può funzionare con il cambio rovesciato
S: without brake lever, the original one to be used - senza leva del freno, si utilizza quella originale
T: it is not necessary to mount the hydrostop - non è necessario montare l'hydrostop
U: use the code KK01 to order rearsets with folding foot-pegs already mounted
 utilizzare il codice KK01 per ordinare le pedane con i poggiatesta chiudibili
V: Includes folding foot-pegs - Include poggiatesta chiudibili

Please note: some models may need to replace the rear brake tubes
 Attenzione: per alcuni modelli potrebbe essere necessario sostituire i tubi freni posteriori

APRILIA

| MODEL - MODELLO | FROM - DAL | TO - AL | CODE - CODICE | € | NOTES - NOTE |
|---------------------------------------------------------|------------|---------|---------------|--------|--------------|
| RSV Mille - TUONO * | 1998 | 2003 | A001 | 307,00 | A/U |
| RSV 1000 - TUONO * | 2004 | 2008 | A002 | 307,00 | A/U |
| RSV4 - TUONO V4 | 2009 | 2016 | A003 | 455,00 | N/R/F/P/U |
| RSV4 APRC - TUONO V4 APRC (street) | 2011 | 2016 | A004 | 455,00 | N/P/U |
| RSV4 APRC - TUONO V4 APRC (race) | 2011 | 2016 | A004R | 455,00 | R/P/U |
| RSV4 - RSV4 RF - RSV4 <i>Factory</i> - TUONOV4 (street) | 2017 | > | A005S | 544,00 | N/P/U |
| RSV4 - RSV4 RF - RSV4 <i>Factory</i> - TUONOV4 (race) | 2017 | > | A005SR | 544,00 | R/P/U |
| RS 660 - TUONO 660 | 2020 | > | A006 | 708,00 | L/N/P/R/T/U |

* Available only on specific request - * Disponibili solo su specifica richiesta



**APRILIA RSV4 FACTORY
RSV4 RF - TUONO - cod. A005S**



Aprilia RSV4 Factory (2021 / >)
code A005S + accessories RC03

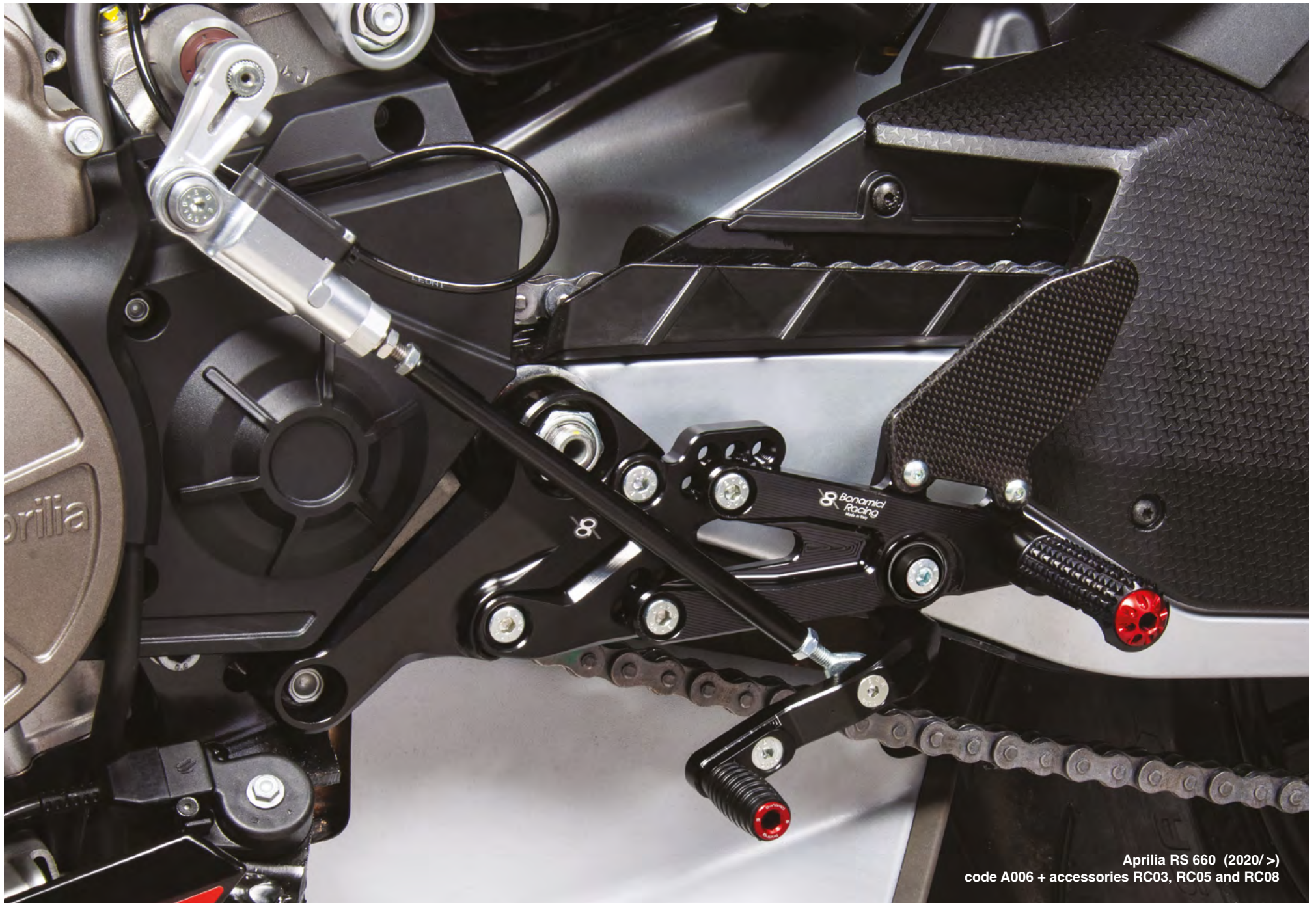

Aprilia RS 660 (2020/ >)
code A006 + accessories RC03, RC05 and RC08

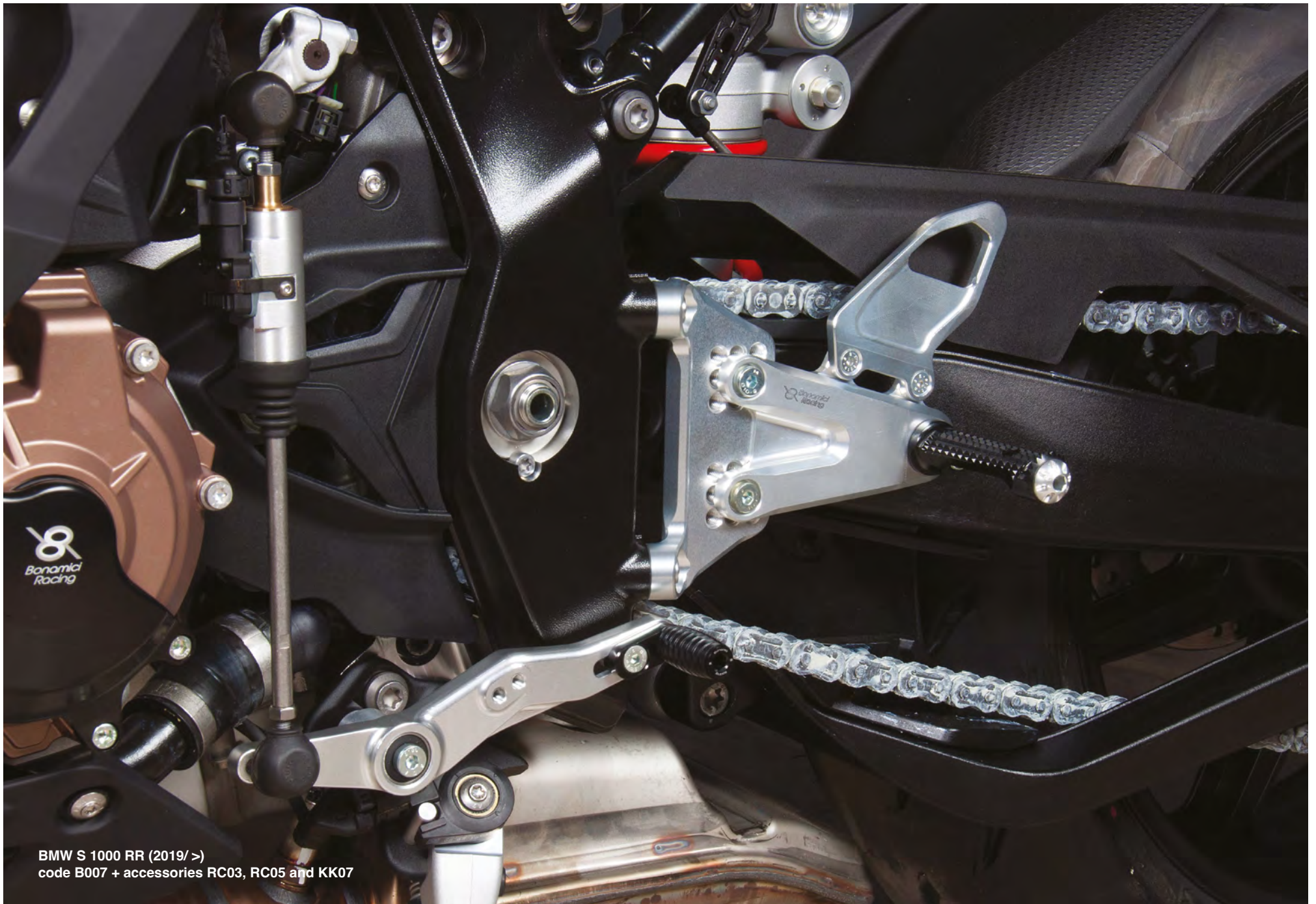

BMW S 1000 RR (2019/ >)
code B007 + accessories RC03, RC05 and KK07

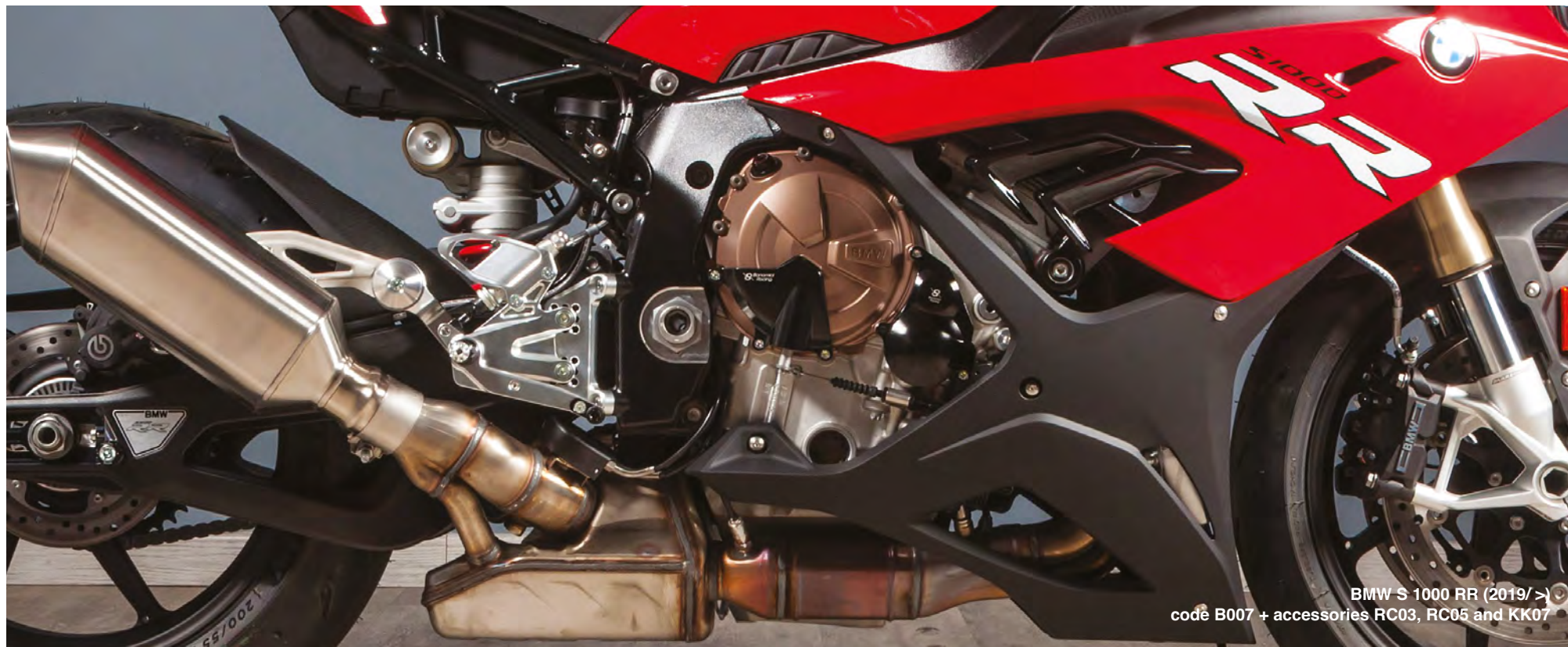

BMW S 1000 RR (2019/ >)
codé B007 + accessories RC03, RC05 and KK07

PRICES WITHOUT VAT - PREZZI IVA ESCLUSA

BMW



● BMW S 1000 RR - cod. B007

| MODEL - MODELLO | FROM - DAL | TO - AL | CODE - CODICE | € | NOTES - NOTE |
|------------------------------------|------------|---------|---------------|--------|--------------|
| S 1000 RR - HP4 (street) | 2008 | 2014 | B001 | 513,00 | I/N/U |
| S 1000 RR - HP4 (race) | 2008 | 2014 | B001R | 416,00 | R/B/M/P/U |
| S 1000 RR | 2015 | 2018 | B005 | 476,00 | N/R/P/U |
| S 1000 RR - M 1000 RR | 2019 | > | B007 | 635,00 | N/R/P/T/U |
| S 1000 R (street) | 2012 | 2016 | B001 | 513,00 | I/N/U |
| S 1000 R (race) | 2012 | 2016 | B001R | 416,00 | R/B/P/U |
| S 1000 R | 2017 | 2020 | B006 | 476,00 | N/R/P/U |
| S 1000 R | 2021 | > | B008 | 635,00 | N/R/P/T/U |
| S 1000 XR | 2020 | > | B009 | 713,00 | N/P/T/V |
| R nineT / Pure / Urban / Scrambler | 2014 | 2020 | B004 | 416,00 | N/L |



Ducati Streetfighter V4 (2020/ >)
code DSTR2 + accessories RC03, KK07 and RC08

PRICES WITHOUT VAT - PREZZI IVA ESCLUSA

DUCATI

| MODEL - MODELLO | FROM - DAL | TO - AL | CODE - CODICE | € | NOTES - NOTE |
|-------------------------------------------------------|------------|---------|---------------|--------|--------------|
| Scrambler 800 single seater - monoposto | 2015 | > | DSCR1 | 486,00 | N |
| Scrambler 800 passenger - passeggero | 2015 | > | DSCR2 | 403,00 | - |
| Scrambler 800 two seater - biposto | 2015 | > | DSCR3 | 888,00 | N |
| 748 / 916 / 996 / 998 | 1994 | 2004 | D916 | 416,00 | N/R/T/U |
| 749 / 999 | 2002 | 2006 | D999 | 416,00 | N/R/T/U |
| 848 / 1098 / 1198 | 2007 | 2011 | D1098 | 416,00 | N/R/T/U |
| 899 / 959 / 1199 / 1299 Panigale | 2012 | 2018 | DV2 | 610,00 | N/R/U |
| Panigale V4 / V4S / V4R | 2018 | > | DV4 | 727,00 | N/R/P/U |
| Panigale V2 | 2020 | > | DV2 | 610,00 | N/R/U |
| Hypermotard | 2007 | 2012 | DH01 | 486,00 | N/R/G/U |
| Hypermotard (race) | 2007 | 2012 | DH02 | 430,00 | N/R/E/G/U |
| Multistrada | 2003 | 2009 | DH01 | 486,00 | N/R/G/U |
| Streetfighter | 2009 | 2015 | DSTR | 528,00 | N/R/H/T/U |
| Streetfighter V4 | 2020 | > | DSTR2 | 727,00 | N/R/P/U |
| Supersport * 620 / 750 / 800 / 900 / 1000 / 1000DS | 1998 | 2007 | DSS | 391,00 | N/R/T/U |
| Paul Smart / Sport 1000 * | 2005 | 2006 | DPS | 391,00 | N/R/U |

* Available only on specific request - * Disponibili solo su specifica richiesta



DUCATI SCRAMBLER 800 two seater - biposto - cod. DSCR3



DUCATI PANIGALE V2 - cod. DV2



DUCATI PANIGALE V4 - cod. DV4



Ducati Streetfighter V4 (2020/ >)
code DSTR2 + accessories RC03, KK07 and RC08

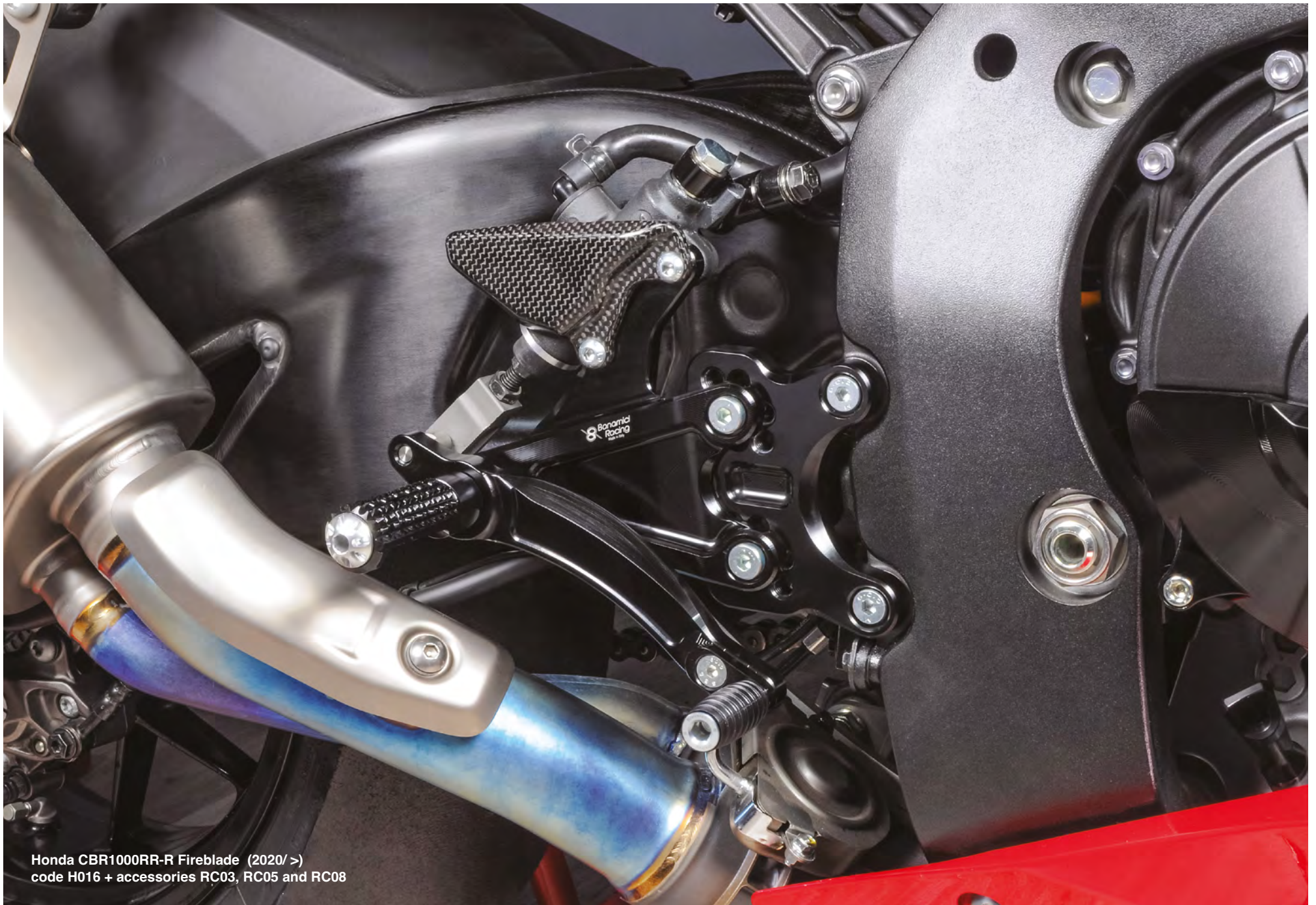

Honda CBR1000RR-R Fireblade (2020/ >)
code H016 + accessories RC03, RC05 and RC08

HONDA

| MODEL - MODELLO | FROM - DAL | TO - AL | CODE - CODICE | € | NOTES - NOTE |
|------------------------------|------------|---------|---------------|--------|--------------|
| CBR 500 R / CB 500 F | 2012 | 2018 | H011 | 371,00 | N/R/U |
| CBR 500 R / CB 500 F | 2019 | > | H017 | 429,00 | G/N/R/U |
| CBR 600 RR (street) | 2003 | 2006 | H001 | 371,00 | N/C/P/U |
| CBR 600 RR (race) | 2003 | 2006 | H003 | 391,00 | R/C/D/P/U |
| CBR 600 RR (street) | 2007 | > | H005 | 371,00 | N/C/P/U |
| CBR 600 RR (race) | 2007 | > | H006 | 391,00 | R/C/D/P/U |
| CBR 1000 RR (street) | 2004 | 2007 | H002 | 371,00 | N/C/P/U |
| CBR 1000 RR (race) | 2004 | 2007 | H004 | 416,00 | R/C/F/M/P/U |
| CBR 1000 RR (street) | 2008 | 2016 | H008 | 445,00 | N/F/P/U |
| CBR 1000 RR (race) | 2008 | 2016 | H009 | 416,00 | R/P/U |
| CBR 1000 RR Fireblade | 2017 | 2019 | H013 | 483,00 | F/N/R/P/U |
| CBR 1000 RR Fireblade SP/SP2 | 2017 | 2019 | H014 | 483,00 | F/N/R/P/U |
| CBR 1000 RR-R "Racing" | 2020 | > | H015 | 537,00 | N/R/O/P/U |
| CBR 1000 RR-R "Standard" | 2020 | > | H016 | 574,00 | N/R/P/U |
| CBR 650 R/CB 650 R/F | 2014 | > | H012 | 408,00 | N/R/U |
| VTR 1000 SP1/SP2 * | 2000 | 2006 | H007 | 391,00 | F/N/R/P/U |

* Available only on specific request - * Disponibili solo su specifica richiesta



HONDA CBR 650 R/CB 650 R/F - cod. H012



HONDA CBR 600 RR (race) - cod. H006



HONDA CBR1000RR-R FIREBLADE - cod. H015

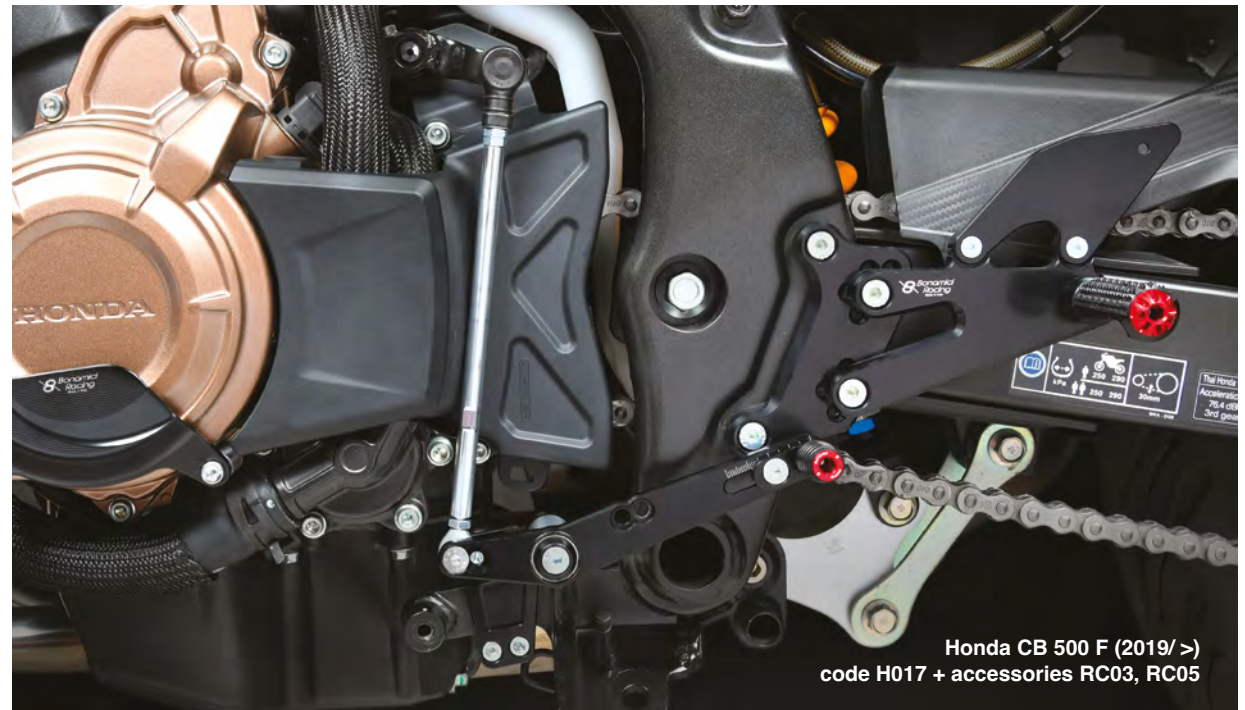

Honda CB 500 F (2019/ >)
code H017 + accessories RC03, RC05

KAWASAKI

| MODEL - MODELLO | FROM - DAL | TO - AL | CODE - CODICE | € | NOTES - NOTE |
|-------------------|------------|---------|---------------|--------|--------------|
| Ninja 250/400 | 2018 | > | K019 | 420,00 | N/R/F/P/U |
| ZX-6R * | 2003 | 2004 | K003 | 391,00 | N/R/P/U |
| ZX-6R | 2005 | 2006 | K005 | 391,00 | N/R/P/U |
| ZX-6R | 2007 | 2008 | K006 | 391,00 | N/R/P/U |
| ZX-6R | 2009 | 2017 | K010 | 391,00 | N/R/P/U |
| ZX-6R | 2019 | > | K020 | 391,00 | N/P/O/U |
| ZX-10R * | 2004 | 2005 | K001 | 391,00 | N/R/P/U |
| ZX-10R | 2006 | 2007 | K002 | 391,00 | N/R/P/U |
| ZX-10R | 2008 | 2010 | K008 | 391,00 | N/R/P/U |
| ZX-10R | 2011 | 2015 | K012 | 408,00 | N/R/F/P/U |
| ZX-10R | 2016 | 2020 | K015 | 408,00 | N/F/P/U |
| NEW ZX-10R | 2021 | > | K021 | 635,00 | N/R/F/U |
| ER-6N * | 2007 | 2008 | K007A | 416,00 | N/R/E/P/U |
| ER-6N * | 2009 | 2011 | K007B | 416,00 | N/R/E/P/U |
| Z 650/Ninja 650 | 2017 | 2019 | K018 | 483,00 | N/R/F/P/U |
| Z 750 * | 2004 | 2006 | K004 | 391,00 | N/R/P/U |
| Z 750 * | 2007 | 2012 | K009 | 391,00 | N/R/P/U |
| Z 900 | 2017 | 2019 | K017 | 408,00 | N/R/F/P/U |
| Z 1000 | 2007 | 2009 | K009 | 391,00 | N/R/P/U |
| Z 1000 | 2010 | 2018 | K011 | 391,00 | N/P/U |



KAWASAKI ZX-10R - cod. K021



790 / 890 Duke / 890 Duke R - cod. KT04

KTM

| MODEL - MODELLO | FROM - DAL | TO - AL | CODE - CODICE | € | NOTES - NOTE |
|-----------------------------|------------|---------|---------------|--------|--------------|
| Duke 125 / 200 / 250 / 390 | 2014 | 2020 | KT01 | 519,00 | N/R/P/U |
| RC125 / 200 / 250 / 390 | 2014 | 2020 | KT01 | 519,00 | N/R/P/U |
| 790 / 890 Duke / 890 Duke R | 2018 | > | KT04 | 499,00 | N/R/P/T/U |
| 1290 Superduke / R / GT | 2013 | 2019 | KT03 | 455,00 | N/R/P/U |
| 1290 Superduke R | 2020 | > | KT05 | 485,00 | N/R/T/U |

MV AGUSTA

| MODEL - MODELLO | FROM - DAL | TO - AL | CODE - CODICE | € | NOTES - NOTE |
|-----------------------------------------------|------------|---------|---------------|--------|--------------|
| Brutale / Dragster 675/800 | 2012 | 2015 | MV02 | 531,00 | N/U |
| F3 675 / 800 | 2011 | 2016 | MV02 | 531,00 | N/R/U |
| F3 675 / 800 Quickshifter (race) | 2011 | 2016 | MV02R | 531,00 | R/U |
| F4 / Brutale (street) * | 1998 | 2019 | MV01 | 344,00 | A/U |
| F4 / Brutale (without QS - senza QS) (race) * | 1998 | 2019 | MV01R | 391,00 | R/S/U |



MV AGUSTA F4 / Brutale (race)
without Quickshifter - senza Quickshifter - cod. MV01R

* Available only on specific request - * Disponibili solo su specifica richiesta

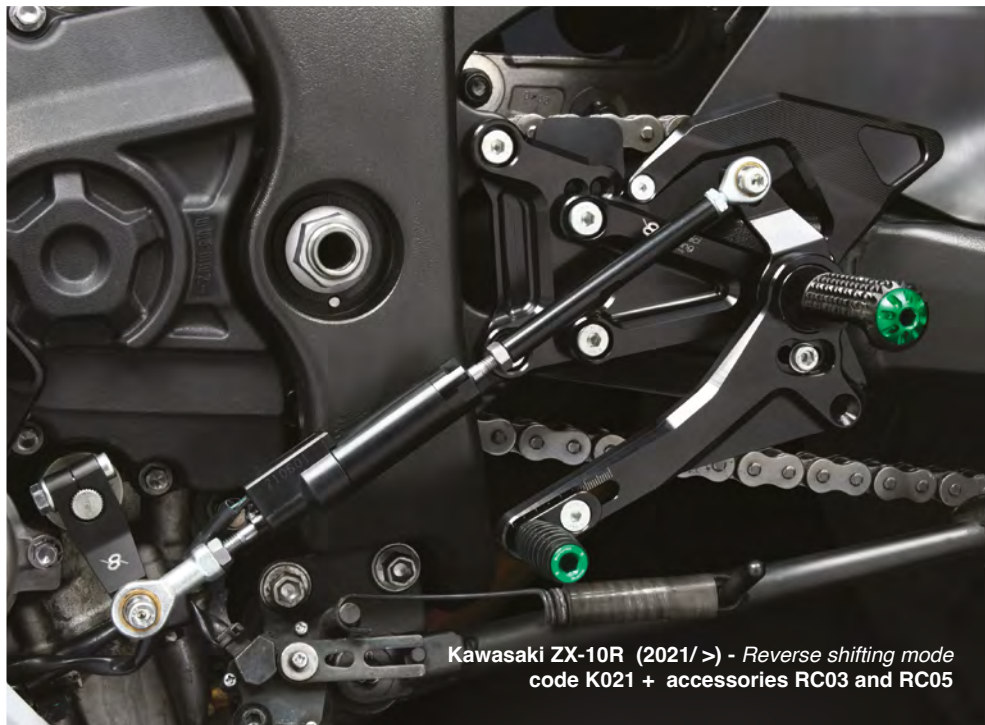

Kawasaki ZX-10R (2021/ >) - Reverse shifting mode
code K021 + accessories RC03 and RC05

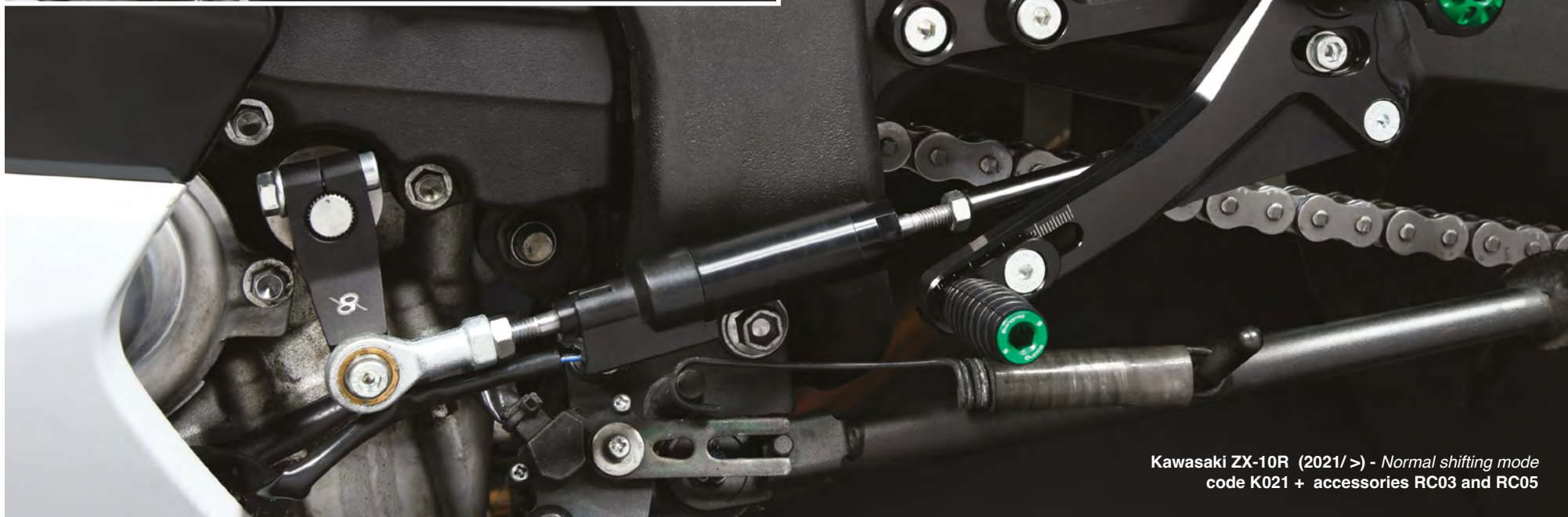

Kawasaki ZX-10R (2021/ >) - Normal shifting mode
code K021 + accessories RC03 and RC05

Triumph Speed Triple 1200 RR (2022/>)
code TH07 + accessories RC03 and RC05

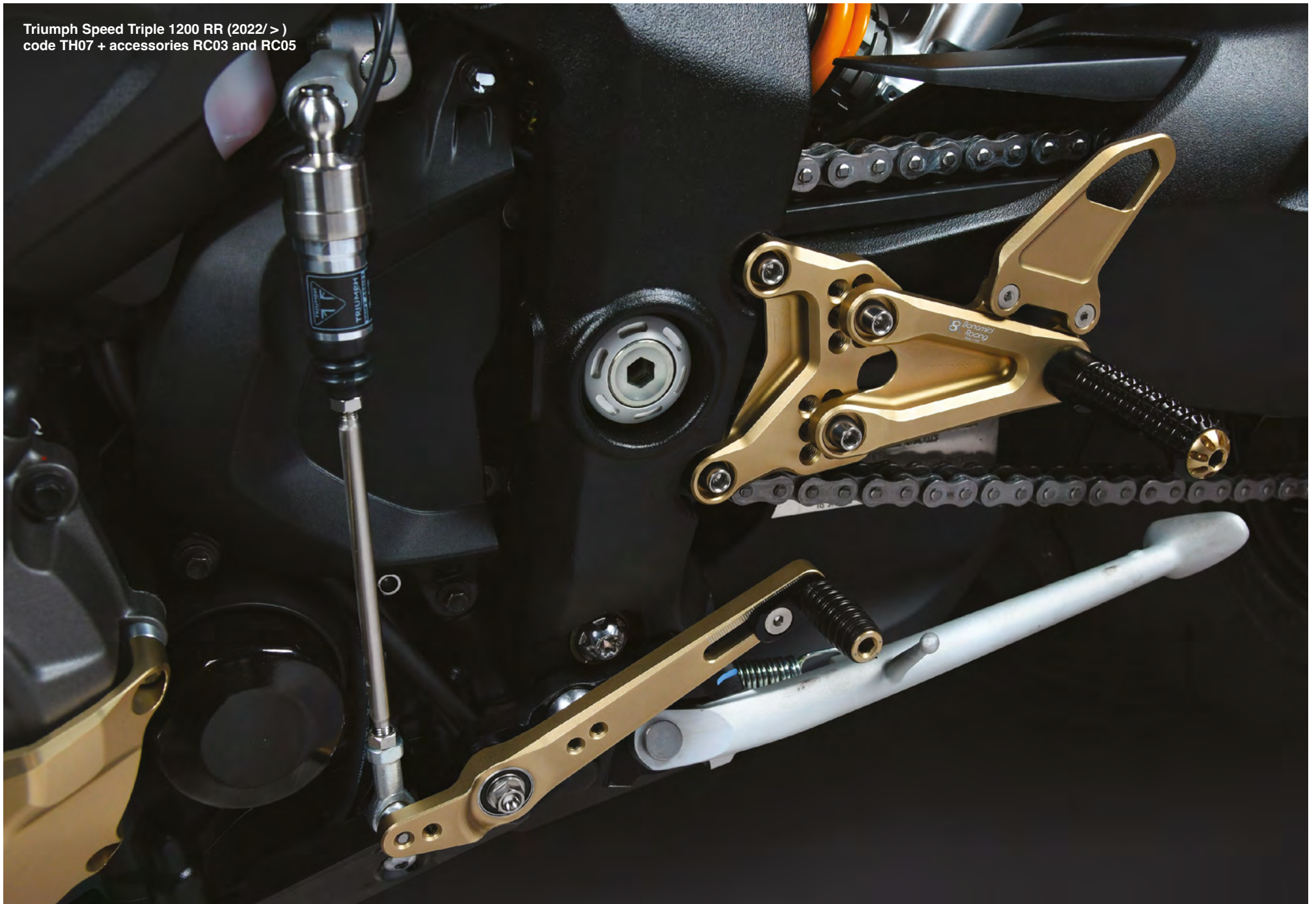

SUZUKI



● SUZUKI GSX-R 1000 - cod. S011

| MODEL - MODELLO | FROM - DAL | TO - AL | CODE - CODICE | € | NOTES - NOTE |
|---------------------|------------|---------|---------------|--------|--------------|
| GSX-R 600 / 750 * | 2004 | 2005 | S003 | 371,00 | N/R/P/U |
| GSX-R 600 / 750 | 2006 | 2010 | S004 | 408,00 | N/R/P/U |
| GSX-R 600 / 750 | 2011 | 2017 | S008 | 391,00 | N/R/P/U |
| GSX-R 1000 * | 2003 | 2004 | S002 | 371,00 | N/R/P/U |
| GSX-R 1000 * | 2005 | 2006 | S001 | 371,00 | N/R/P/U |
| GSX-R 1000 | 2007 | 2008 | S006 | 391,00 | N/R/P/U |
| GSX-R 1000 | 2009 | 2016 | S007 | 391,00 | N/R/P/U |
| GSX-R 1000 | 2017 | > | S011 | 483,00 | N/R/P/U |
| SV 1000 * | 2004 | 2008 | S005 | 371,00 | N/R/P/U |
| GSR 750 / GSX-S 750 | 2011 | 2019 | S009 | 391,00 | N/R/P/U |
| GSX-S 1000 / 1000F | 2015 | 2020 | S010 | 391,00 | N/R/P/U |
| GSX-S 1000 | 2021 | > | S013 | 391,00 | N/R/P/U |

TRIUMPH



● TRIUMPH SPEED TRIPLE 1200 RR - cod. TH07

| MODEL - MODELLO | FROM - DAL | TO - AL | CODE - CODICE | € | NOTES - NOTE |
|-----------------------------------------------------------|------------|---------|---------------|--------|--------------|
| Daytona/Street Triple 675 without Quickshifter - senza QS | 2006 | 2012 | TH01 | 416,00 | N/R/P/U |
| Daytona 675 without Quickshifter - senza QS | 2013 | 2017 | TH03 | 465,00 | F/N/R/U |
| Daytona 675 Quickshifter (street) | 2013 | 2017 | TH03 | 465,00 | F/N/U |
| Daytona 675 Quickshifter (race) | 2013 | 2017 | TH03R | 465,00 | F/R/U |
| Street Triple 675 | 2013 | 2016 | TH04 | 465,00 | F/N/R/U |
| Street Triple S/R/RS 765 | 2017 | > | TH06 | 531,00 | F/N/R/L/P/U |
| Speed Triple 1050 | 2004 | 2010 | TH02 | 416,00 | N/R/P/D1/U |
| Speed Triple 1050 (street) | 2011 | 2020 | TH05 | 435,00 | F/N/P/T/D/U |
| Speed Triple 1050 (race) | 2011 | 2020 | TH05R | 435,00 | F/R/T/D/U |
| NEW Speed Triple 1200 RS | 2021 | > | TH08 | 537,00 | N/R/T/U |
| NEW Speed Triple 1200 RR | 2022 | > | TH07 | 537,00 | N/R/T/U |

YAMAHA



● YAMAHA YZF R6 - cod. Y013

| MODEL - MODELLO | FROM - DAL | TO - AL | CODE - CODICE | € | NOTES - NOTE |
|-----------------|------------|---------|---------------|--------|--------------|
| YZF R3 / R25 | 2015 | > | Y012 | 391,00 | F/N/R/P/U |
| YZF R6 * | 1999 | 2002 | Y003 | 408,00 | N/P/U |
| YZF R6 * | 2003 | 2005 | Y004 | 408,00 | N/F/P/U |
| YZF R6 | 2006 | 2016 | Y005 | 408,00 | N/R/P/U |
| YZF R6 | 2017 | > | Y013 | 455,00 | N/R/U |
| YZF R1 * | 1998 | 2003 | Y001 | 408,00 | N/R/P/U |

* Available only on specific request - * Disponibili solo su specifica richiesta

YAMAHA

| MODEL - MODELLO | FROM - DAL | TO - AL | CODE - CODICE | € | NOTES - NOTE |
|-----------------------------------------------------------------|------------|---------|---------------|--------|--------------|
| YZF R1(street) * | 2004 | 2006 | Y002 | 416,00 | N/F/P/U |
| YZF R1(race) * | 2004 | 2006 | Y002R | 408,00 | R/B/P/U |
| YZF R1(street) | 2007 | 2008 | Y006 | 416,00 | N/C/F/P/U |
| YZF R1(race) | 2007 | 2008 | Y006R | 408,00 | R/C/P/U |
| YZF R1 | 2009 | 2014 | Y007 | 408,00 | N/R/P/U |
| YZF R1/R1M | 2015 | > | Y011 | 519,00 | N/R/P/U |
| YZF R7 | 2021 | > | Y015 | 455,00 | N/R/T/U |
| FZ8 - FZ1 | 2006 | 2015 | Y009 | 408,00 | N/F/P/U |
| MT-07/FZ07 | 2014 | 2020 | Y010 | 408,00 | N/R/P/U |
| MT-09 / FZ09 / XSR 900 / Tracer without Quickshifter - senza QS | 2013 | 2020 | Y008 | 455,00 | N/R/U |
| MT-10 / FZ10 | 2016 | 2020 | Y014 | 483,00 | N/R/P/U |



YAMAHA YZF R1/R1M - cod. Y011

WARNING
ATTENZIONE

- Before use, make sure that all screws are tightened with care. Use light strength thread-locker.
- The assistance of professional staff is necessary for all the parts which require installation.
- All Bonamici Racing products are made for racing use only (not for street use).
- After any kind of impact, it is obligatory to replace the affected parts.
- It is obligatory to check the tightened of the screws after every ride session.

- Prima dell'uso, assicurarsi che tutte le viti siano serrate con cura. Usa un frenafili.
- Per tutte le parti che necessitano di installazione è necessaria l'assistenza di personale qualificato.
- Tutti i prodotti Bonamici Racing sono realizzati esclusivamente per uso agonistico (non per uso stradale).
- Dopo ogni tipo di urto è obbligatorio sostituire le parti interessate.
- È obbligatorio controllare il serraggio delle viti dopo ogni sessione di guida.

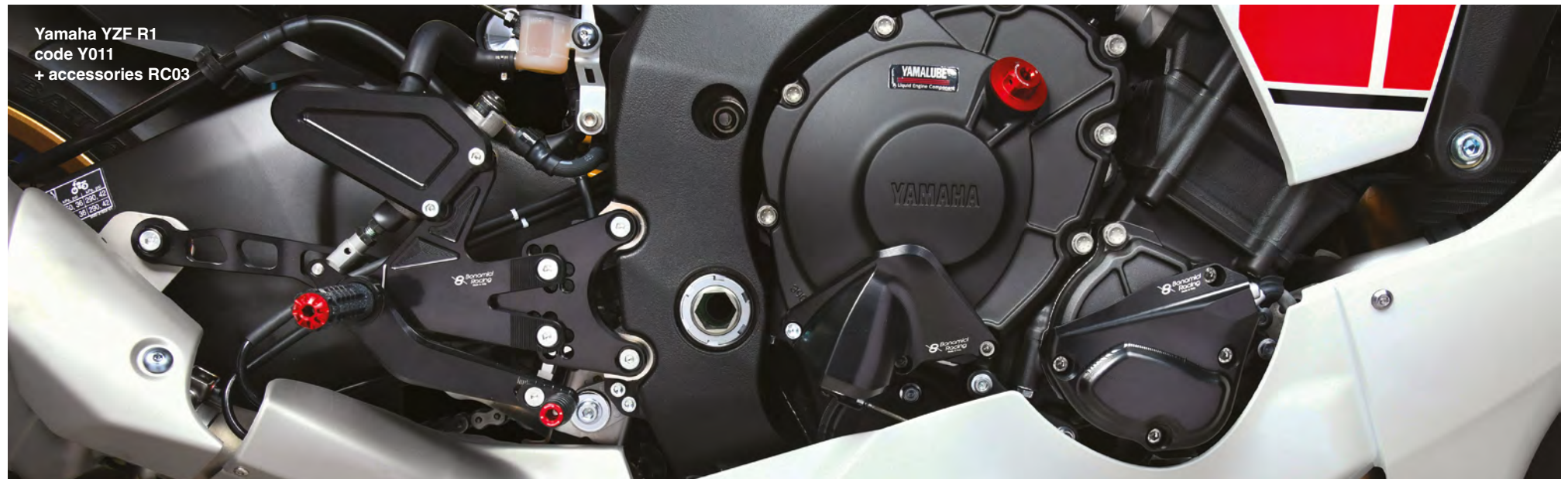

Yamaha YZF R1
code Y011
+ accessories RC03

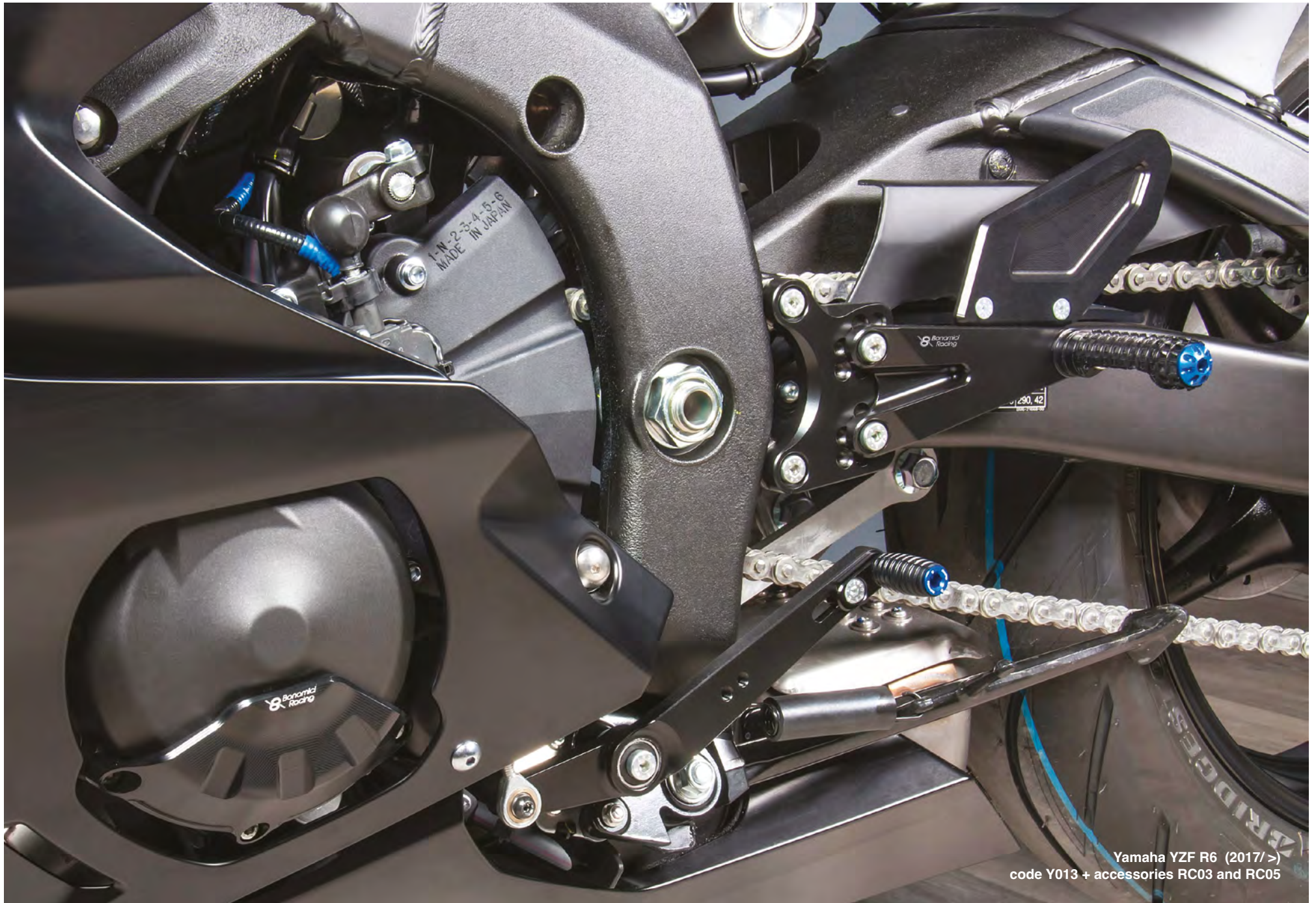

Yamaha YZF R6 (2017/ >)
code Y013 + accessories RC03 and RC05

REARSETS ACCESSORIES - ACCESSORI PEDANE

The full range of Bonamici Racing rearsets is supplied in the "Standard" version with black color, aluminum heelplates, fixed foot-pegs and front-pegs. At the time of purchase it is possible to request the rearsets in different colors and with laser engraving, the rest of the accessories can all be purchased separately. Pay attention to the "notes" on the rearsets page.

L'intera gamma pedane Bonamici Racing è fornita nella versione "Standard" con colore nero, paratacchi in alluminio, poggia piedi e puntalini fissi. Al momento dell'acquisto è possibile richiedere la pedana in diversi colori e con incisione laser, il resto degli accessori sono acquistabili tutti separatamente. Fare attenzione alle "note" nella pagina pedane.

DESCRIPTION - DESCRIZIONE CODE - CODICE € NOTES - NOTE

| | | | |
|----------------------------------------------------------------------------------------------------------|-------|--------|------|
| Pair of racing foot pegs Coppia di poggia piedi racing | RC05 | 95,00 | - |
| Pair of fold-up footpegs with note rearsets "U" Coppia di poggia piedi chiudibili con nota pedane "U" | KK01 | 55,00 | 1 |
| Pair of standard fold-up front-pegs Coppia di puntalini chiudibili standard | RC02 | 84,00 | - |
| Pair of knurled fold-up front-pegs Coppia di puntalini chiudibili godronati | RC02G | 110,00 | - |
| Pair of striped fold-up front-pegs Coppia di puntalini chiudibili rigati | RC02R | 110,00 | - |
| Laser engravings (one pair) Incisioni laser (coppia) | KK04 | 25,00 | 1 |
| Pair of carbon heel plates Coppia di paratacchi in carbonio | RC08 | 75,00 | 3 |
| Hydrostop M10 x 1 Interruttore stop idraulico M10 x 1 | HD100 | 26,00 | 4 |
| Hydrostop M10 x 1,25 Interruttore stop idraulico M10 x 1,25 | HD125 | 26,00 | 4 |
| Wired hydrostop for Ducati Interruttore stop cablato per Ducati | HDC01 | 44,00 | - |
| Wired hydrostop for Ducati Streetfighter V4 Interruttore stop cablato per Ducati Streetfighter V4 | HDC02 | 44,00 | - |
| Spring kit rearsset Pacco molla pedane | RC06 | 59,00 | 2 |
| Pairs of colored aluminum caps and frontpegs Coppie di tappi e puntalini in alluminio colorati | RC03 | 52,00 | - |
| Extra colour for rear set Colore extra per pedane | KK07 | 90,00 | 1- 5 |
| NEW Aluminium stand for rearsets Espositore pedane in Alluminio | EX01 | 45,00 | - |

NOTES - NOTE

- 1: Available only by purchasing a new rearsset - Disponibile solo durante l'acquisto di una pedana nuova
- 2: Available on Aprilia RSV4, BMW S1000RR, Yamaha YZF R1 '15/'20 - Disponibile per Aprilia RSV4, BMW S1000RR, Yamaha YZF R1 '15/'20
- 3: To verify the possibility in the rearsset notes ("P") - Verificare la possibilità nelle note delle pedane ("P")
- 4: Available only for the OEM switch stop with two cables - Disponibile solo per impianti stop originali a due cavi
- 5: Footpegs, caps and frontpegs in full black - Poggia piedi, tappi e puntalini neri

WARNING ATTENZIONE

- It's possible to find all the spare parts on the specific catalog
- È possibile trovare tutte le parti di ricambio sul catalogo specifico



Racing foot peg / Poggia piedi racing - cod. RC05 Fold-up foot pegs / poggia piedi chiudibili - cod. KK01



Fold-up front-pegs standard Puntalini chiudibili standard cod. RC02 Knurled fold-up front-pegs Puntalini chiudibili godronati cod. RC02G Striped fold-up front-pegs Puntalini chiudibili rigati - cod. RC02R

GEAR SPACER SUPPORT - SUPPORTO DISTANZIALE CAMBIO

Spacer who allows the munting of the rearsets without using the side stand.

Supporto per montare le pedane senza l'utilizzo del cavalletto laterale.

| MODEL - MODELLO | FROM - DAL | TO - AL | CODE - CODICE | € |
|---------------------------|------------|---------|---------------|-------|
| Honda CBR 1000RR-R | 2020 | > | DC_040B | 98,00 |
| BMW S 1000 RR - M 1000 RR | 2019 | > | DC_039B | 86,00 |
| BMW S 1000 R | 2021 | > | DC_039B | 86,00 |
| Yamaha YZF R6 | 2017 | > | DC_037B | 86,00 |



Pairs of caps and standard frontpegs coloured
Coppie di tappi e puntalini standard colorati - cod. RC03



• The rearsets pictured is for illustrative purposes only
• La pedana nella foto è solo a scopo illustrativo

Extra colour for rearset - Colore extra per pedane - cod. KK07



Hydrostop M10 x 1
Interruttore stop idraulico M10 x 1 - cod. HD100

Hydrostop M10 x 1,25
Interruttore stop idraulico M10 x 1,25 - cod. HD125



Wired hydrostop for Ducati
Interruttore stop cablato per Ducati - cod. HDC01



Wired hydrostop for Ducati Streetfighter V4
Interruttore stop cablato per Ducati Streetfighter V4 - cod. HDC02



Laser engravings (one pair)
Incisioni laser (coppia) - cod. KK04

• The heelplates pictured is for illustrative purposes only
• I paratacchi nella foto sono solo a scopo illustrativo



Pair of carbon heel plates
Coppia di paratacchi in carbonio - cod. RC08



Scott Redding, BMW Motorrad WorldSBK team rider, shows the Bonamic Racing rearset



Iker Lecuona, WorldSBK TeamHRC rider, shows the Bonamici Racing rearset

ENGINE PROTECTIONS - PROTEZIONI MOTORE



The Bonamici Racing engine protection comes from the collaboration with the teams involved in the World Superbike Championship.

Made by high-strength aluminum alloy, machined from solid with CNC technology and finished with black anodizing, the engine cover kit perfectly protects the carter during falls and slides. It is composed by two or three elements, depending by the model, who protect the carter on both sides of the bike.

The engine protections can be purchased both in kit and individually and it's possible to customize them in other colors or with laser engraving according to customer specifications.

Bonamici Racing boasts the widest range of aluminum engine protections dedicated to the major sport-bikes on the market.

Dalla collaborazione con i team che corrono nel mondiale superbike, nascono le protezioni carter motore della Bonamici Racing.

In lega d'alluminio ad alta resistenza, lavorato dal pieno con tecnologia CNC e rifinito con anodizzazione nera, il kit protegge perfettamente i carter della moto in caso di eventuali cadute.

E' composto da due o tre elementi che proteggono i carter da entrambi i lati della moto. Le protezioni carter sono disponibili sia in kit che singolarmente ed è possibile personalizzarle in altri colori o con incisione laser su specifica del cliente.

Bonamici Racing vanta la più ampia gamma di protezioni motore in alluminio dedicate alle maggiori moto sportive del mercato.

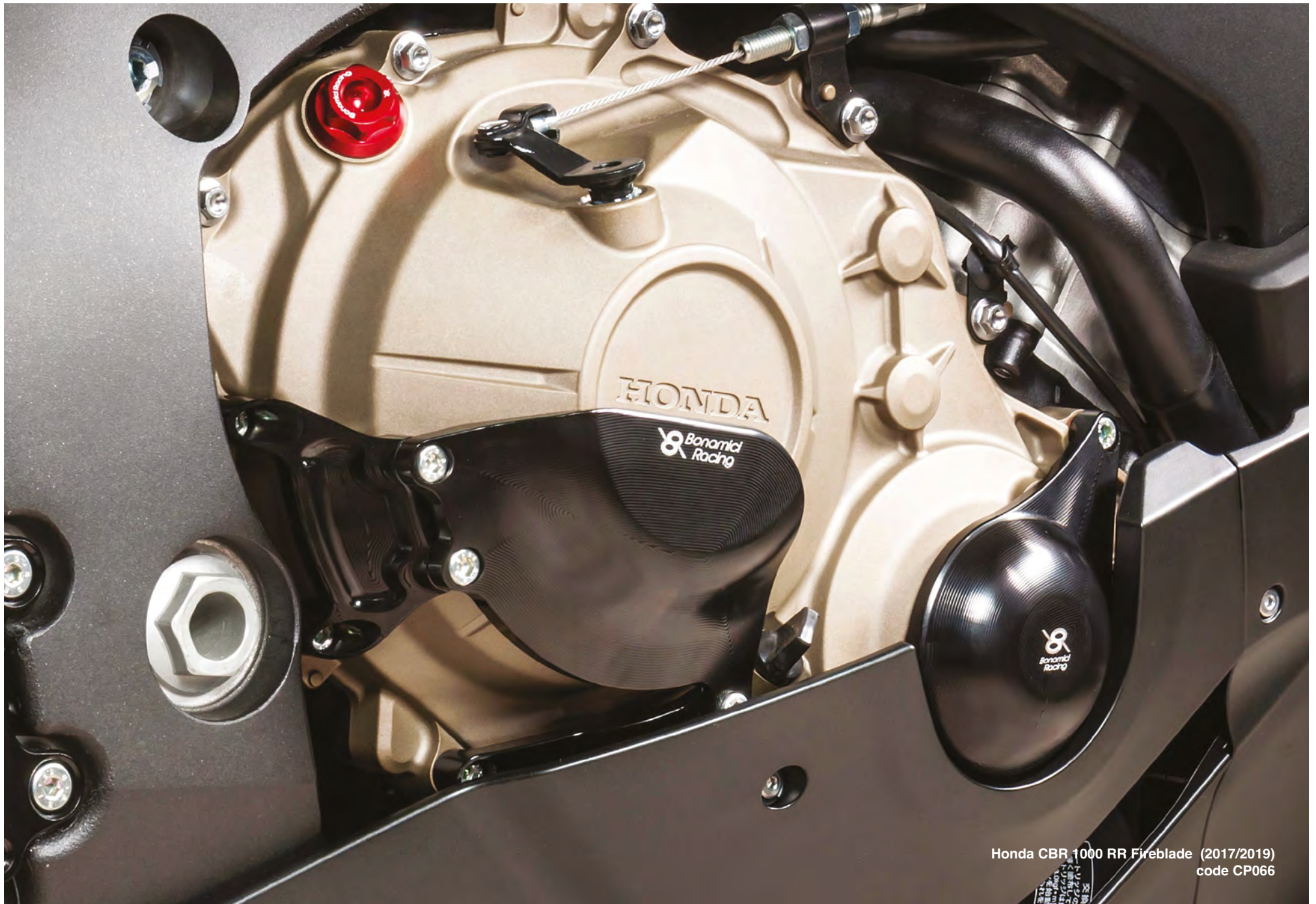

Honda CBR 1000 RR Fireblade (2017/2019)
code CP066

| MODEL - MODELLO | DESCRIPTION - DESCRIZIONE | FROM - DAL | TO - AL | CODE - CODICE | € |
|--------------------------------|-------------------------------------------------|------------|---------|---------------|--------|
| RSV4 - TUONO V4 | right side - lato DX | 2009 | 2020 | CP001 | 241,00 |
| RSV4 - TUONO V4 | left side - lato SX | 2009 | 2020 | CP002 | 118,00 |
| RSV4 - TUONO V4 | full kit - kit completo | 2009 | 2020 | CP003 | 359,00 |
| RSV4 - RSV4 FACTORY - TUONO V4 | right side - lato DX | 2021 | > | CP001 | 241,00 |
| RSV4 - RSV4 FACTORY - TUONO V4 | left side - lato SX | 2021 | > | CP106 | 118,00 |
| RSV4 - RSV4 FACTORY - TUONO V4 | full kit - kit completo | 2021 | > | CP107 | 359,00 |
| RS 660 - TUONO 660 | right side - lato DX | 2020 | > | CP111 | 211,00 |
| RS 660 - TUONO 660 | left side - lato SX | 2020 | > | CP112 | 137,00 |
| RS 660 - TUONO 660 | left side (water pump) lato SX (pompa acqua) | 2020 | > | CP113 | 112,00 |
| RS 660 - TUONO 660 | full kit - kit completo | 2020 | > | CP114 | 458,00 |



APRILIA RSV4 - TUONO V4 (2009/2020)
full kit - kit completo - cod. CP003



APRILIA RSV4 Factory (2021 / >)
full kit - kit completo - cod. CP107



APRILIA RS 660 (2020 / >)
full kit - kit completo - cod. CP114

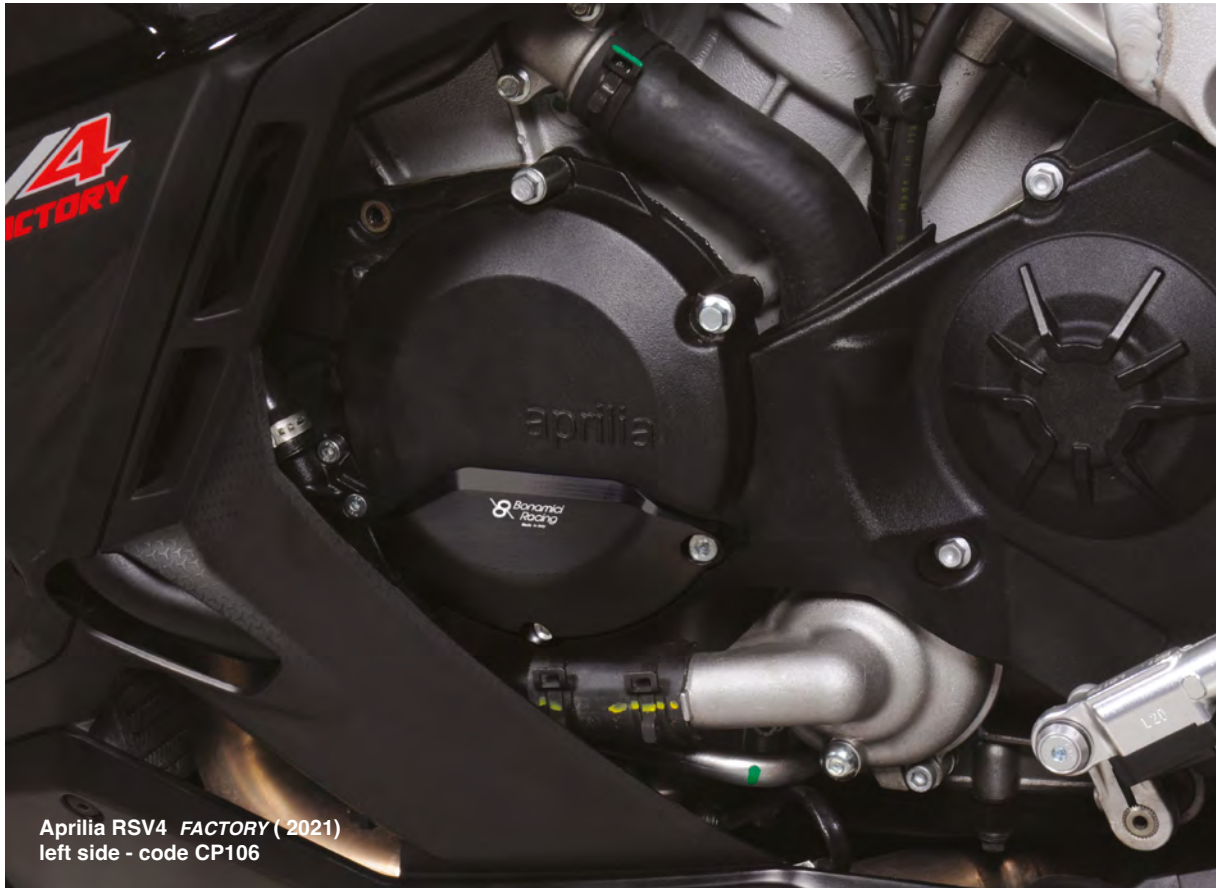

Aprilia RSV4 FACTORY (2021)
left side - code CP106

* Available only on specific request - * Disponibili solo su specifica richiesta



Aprilia RSV4 FACTORY (2021)
right side - code CP001

| MODEL - MODELLO | DESCRIPTION - DESCRIZIONE | FROM - DAL | TO - AL | CODE - CODICE | € |
|-----------------------------------|---------------------------------------------------------|------------|---------|---------------|--------|
| S 1000 RR - S 1000 R | right side - lato DX | 2008 | 2016 | CP004 | 76,00 |
| S 1000 RR - S 1000 R <i>SBK</i> * | right side - lato DX | 2008 | 2016 | CP004B | 100,00 |
| S 1000 RR - S 1000 R | right side (clutch) lato DX (frizione) | 2008 | 2016 | CP004C | 121,00 |
| S 1000 RR - S 1000 R | left side lato SX | 2008 | 2016 | CP005 | 186,00 |
| S 1000 RR - S 1000 R | full kit 3pcs. - kit completo 3pz. | 2008 | 2016 | CP006 | 383,00 |
| S 1000 RR - S 1000 R <i>SBK</i> * | full kit 3pcs. - kit completo 3pz. | 2008 | 2016 | CP006B | 406,00 |
| S 1000 RR | right side - lato DX | 2017 | 2018 | CP004 | 76,00 |
| S 1000 RR <i>SBK</i> * | right side - lato DX | 2017 | 2018 | CP004B | 100,00 |
| S 1000 RR | right side (clutch) lato DX (frizione) | 2017 | 2018 | CP004D | 121,00 |
| S 1000 RR | left side lato SX | 2017 | 2018 | CP005 | 186,00 |
| S 1000 RR | full kit 3pcs. - kit completo 3pz. | 2017 | 2018 | CP006C | 383,00 |
| S 1000 RR <i>SBK</i> * | full kit 3pcs. - kit completo 3pz. | 2017 | 2018 | CP006D | 406,00 |
| S 1000 R | right side - lato DX | 2017 | 2020 | CP004 | 76,00 |
| S 1000 R <i>SBK</i> * | right side - lato DX | 2017 | 2020 | CP004B | 100,00 |
| S 1000 R | right side (clutch) lato DX (frizione) | 2017 | 2020 | CP004D | 121,00 |
| S 1000 R | left side lato SX | 2017 | 2020 | CP005 | 186,00 |
| S 1000 R | full kit 3pcs. - kit completo 3pz. | 2017 | 2020 | CP006C | 383,00 |
| S 1000 R <i>SBK</i> * | full kit 3pcs. - kit completo 3pz. | 2017 | 2020 | CP006D | 406,00 |
| S 1000 RR - M 1000 RR | right side (pick-up) - lato DX (pick-up) | 2019 | > | CP084C | 149,00 |
| S 1000 RR - M 1000 RR | right side (clutch) - lato DX (frizione) | 2019 | > | CP085B | 124,00 |
| S 1000 RR - M 1000 RR | left side - lato SX | 2019 | > | CP082 | 112,00 |
| S 1000 RR - M 1000 RR | left side "racing" (2pcs.) lato SX "racing" (2pz.) | 2019 | > | CP082B | 185,00 |
| S 1000 RR - M 1000 RR | left side (water pump) lato SX (pompa acqua) | 2019 | > | CP083 | 88,00 |
| S 1000 RR - M 1000 RR | full kit (4pcs.) kit completo (4pz.) | 2019 | > | CP086 | 470,00 |
| S 1000 RR - M 1000 RR | full kit "racing" (5pcs.) kit compl. "racing" (5pz.) | 2019 | > | CP086B | 544,00 |
| S 1000 R | right side (pick-up) - lato DX (pick-up) | 2021 | > | CP084C | 149,00 |
| S 1000 R | right side (clutch) - lato DX (frizione) | 2021 | > | CP085B | 124,00 |
| S 1000 R | left side - lato SX | 2021 | > | CP082 | 112,00 |
| S 1000 R | left side "racing" (2pcs.) lato SX "racing" (2pz.) | 2021 | > | CP082B | 185,00 |
| S 1000 R | left side (water pump) lato SX (pompa acqua) | 2021 | > | CP083 | 88,00 |
| S 1000 R | full kit (4pcs.) kit completo (4pz.) | 2021 | > | CP086 | 470,00 |
| S 1000 R | full kit "racing" (5pcs.) kit compl. "racing" (5pz.) | 2021 | > | CP086B | 544,00 |



BMW S 1000 RR (2019 / >)
BMW M 1000 RR (2021 / >)
BMW S 1000 R (2021 / >)
full kit (5 pcs.) - kit completo (5 pz.) - Cod.CP086B



Left side "racing" (2pcs.)
 Cod.CP082B

CP086B composed by 5 pieces including the new protection for Crankshaft Sensor (CP082B), the latest invention of Bonamici Racing, especially useful for use on track.

CP086B composto da 5 pezzi tra cui la nuova protezione per Sensore Albero Motore (CP082B), ultima invenzione di Bonamici Racing, particolarmente utile per l'utilizzo in pista.



BMW S 1000 XR (2020 / >) full kit (4 pcs.)
kit completo (4 pz.) - Cod.CP116

| MODEL - MODELLO | DESCRIPTION - DESCRIZIONE | FROM - DAL | TO - AL | CODE - CODICE | € |
|-----------------|-------------------------------------------------|------------|---------|---------------|--------|
| S 1000 XR | right side (pick-up) - lato DX (pick-up) | 2020 | > | CP084C | 149,00 |
| S 1000 XR | right side (clutch) - lato DX (frizione) | 2020 | > | CP085B | 124,00 |
| S 1000 XR | left side - lato SX | 2020 | > | CP115 | 112,00 |
| S 1000 XR | left side (water pump) lato SX (pompa acqua) | 2020 | > | CP083 | 88,00 |
| S 1000 XR | full kit (4pcs.) kit completo (4pz.) | 2020 | > | CP116 | 470,00 |



BMW S 1000 R (2021 / >)
code CP086B

DUCATI

| MODEL - MODELLO | DESCRIPTION - DESCRIZIONE | FROM - DAL | TO - AL | CODE - CODICE | € |
|----------------------|---------------------------|------------|---------|---------------|--------|
| 959 Panigale | right side - lato DX | 2016 | 2018 | CP007 | 197,00 |
| 959 Panigale | left side - lato SX | 2016 | 2018 | CP008B | 174,00 |
| 959 Panigale | full kit - kit completo | 2016 | 2018 | CP009B | 370,00 |
| 1199/1299 Panigale | right side - lato DX | 2018 | 2018 | CP007 | 197,00 |
| 1199/1299 Panigale | left side - lato SX | 2012 | 2018 | CP008A | 174,00 |
| 1199/1299 Panigale | full kit - kit completo | 2012 | 2018 | CP009A | 370,00 |
| Panigale V4/V4S | right side - lato DX | 2018 | > | CP079 | 198,00 |
| Panigale V4/V4S | left side - lato SX | 2018 | > | CP080 | 161,00 |
| Panigale V4/V4S | full kit - kit completo | 2018 | > | CP081 | 359,00 |
| Panigale V4R | right side - lato DX | 2018 | > | CP079B | 198,00 |
| Panigale V4R | left side - lato SX | 2018 | > | CP080 | 161,00 |
| Panigale V4R | full kit - kit completo | 2018 | > | CP081B | 359,00 |
| Panigale V2 | right side - lato DX | 2020 | > | CP007 | 197,00 |
| Panigale V2 | left side - lato SX | 2020 | > | CP104 | 174,00 |
| Panigale V2 | full kit - kit completo | 2020 | > | CP105 | 370,00 |
| Streetfighter V4/V4S | right side - lato DX | 2020 | > | CP101 | 272,00 |
| Streetfighter V4/V4S | left side - lato SX | 2020 | > | CP102 | 161,00 |
| Streetfighter V4/V4S | full kit - kit completo | 2020 | > | CP103 | 433,00 |



DUCATI PANIGALE V4 / V4S - full kit - kit completo - cod. CP081



STREETFIGHTER V4/V4S - full kit - kit completo - cod. CP103



DUCATI 1199 / 1299 PANIGALE - full kit - kit completo - cod. CP009A



Ducati Panigale V4 (2018/ >)
code CP081





Honda CBR1000RR-R Fireblade (2020/ >)
code CP100



HONDA CBR 500 - R / CB 500 F - full kit - kit completo - cod. CP034



HONDA CBR 600 R/F/X - full kit - kit completo - cod. CP028



HONDA CBR1000RR-R FIREBLADE - full kit - kit completo - cod. CP100



Honda CB 500 F (2019/20)
code CP034 (full kit)

HONDA

PRICES WITHOUT VAT - PREZZI IVA ESCLUSA

| MODEL - MODELLO | DESCRIPTION - DESCRIZIONE | FROM - DAL | TO - AL | CODE - CODICE | € |
|------------------------|--------------------------------------------|------------|---------|---------------|--------|
| CBR 500 R / CB 500 F | right side - lato DX | 2012 | > | CP032 | 157,00 |
| CBR 500 R / CB 500 F | left side - lato SX | 2012 | > | CP033 | 101,00 |
| CBR 500 R / CB 500 F | full kit - kit completo | 2012 | > | CP034 | 258,00 |
| CBR 600 RR * | right side - lato DX | 2007 | > | CP026 | 100,00 |
| CBR 600 RR * | left side - lato SX | 2007 | > | CP027 | 122,00 |
| CBR 600 RR * | full kit - kit completo | 2007 | > | CP028 | 222,00 |
| VTR 1000 SP1/SP2 * | right side - lato DX | 2000 | 2006 | CP094 | 196,00 |
| VTR 1000 SP1/SP2 * | left side - lato SX | 2000 | 2006 | CP095 | 149,00 |
| VTR 1000 SP1/SP2 * | full kit - kit completo | 2000 | 2006 | CP096 | 344,00 |
| CBR 1000 RR * | right side - lato DX | 2008 | 2016 | CP035 | 106,00 |
| CBR 1000 RR * | left side - lato SX | 2008 | 2016 | CP036 | 106,00 |
| CBR 1000 RR * | full kit - kit completo | 2008 | 2016 | CP037 | 211,00 |
| CBR 1000 RR Fireblade | right side (distrib.) - lato DX (distrib.) | 2017 | 2019 | CP063 | 112,00 |
| CBR 1000 RR Fireblade | right side (clutch) - lato DX (frizione) | 2017 | 2019 | CP064 | 186,00 |
| CBR 1000 RR Fireblade | left side - lato SX | 2017 | 2019 | CP065 | 149,00 |
| CBR 1000 RR Fireblade | full kit - kit completo | 2017 | 2019 | CP066 | 445,00 |
| CBR 1000RR-R Fireblade | right side (distrib.) - lato DX (distrib.) | 2020 | > | CP097 | 112,00 |
| CBR 1000RR-R Fireblade | right side (clutch) - lato DX (frizione) | 2020 | > | CP098 | 186,00 |
| CBR 1000RR-R Fireblade | left side - lato SX | 2020 | > | CP099 | 161,00 |
| CBR 1000RR-R Fireblade | full kit - kit completo | 2020 | > | CP100 | 458,00 |

* Available only on specific request - * Disponibili solo su specifica richiesta

KAWASAKI

| MODEL - MODELLO | DESCRIPTION - DESCRIZIONE | FROM - DAL | TO - AL | CODE - CODICE | € |
|-----------------|------------------------------------------------|------------|---------|---------------|--------|
| Ninja 250/400 | right side (water pump) lato DX (pompa acqua.) | 2018 | > | CP075 | 80,00 |
| Ninja 250/400 | right side (clutch) - lato DX (frizione) | 2018 | > | CP076 | 131,00 |
| Ninja 250/400 | left side - lato SX | 2018 | > | CP077 | 137,00 |
| Ninja 250/400 | kit completo | 2018 | > | CP078 | 347,00 |
| ZX-6R | right side - lato DX | 2009 | 2017 | CP038 | 97,00 |
| ZX-6R | left side - lato SX | 2009 | 2017 | CP039 | 174,00 |
| ZX-6R | full kit - kit completo | 2009 | 2017 | CP040 | 270,00 |
| ZX-10R | right side - lato DX | 2011 | > | CP010 | 143,00 |
| ZX-10R | left side - lato SX | 2011 | > | CP011 | 118,00 |
| ZX-10R | full kit - kit completo | 2011 | > | CP012 | 260,00 |



KAWASAKI ZX-6R - full kit - kit completo - cod.CP040

KTM

| MODEL - MODELLO | DESCRIPTION - DESCRIZIONE | FROM - DAL | TO - AL | CODE - CODICE | € |
|-----------------------|------------------------------------------------|------------|---------|---------------|--------|
| RC250/390 | right side - lato DX | 2014 | 2016 | CP055 | 149,00 |
| RC250/390 | left side - lato SX | 2014 | 2016 | CP056 | 198,00 |
| RC250/390 | full kit - kit completo | 2014 | 2016 | CP057 | 347,00 |
| RC250/390 | right side - lato DX | 2017 | 2020 | CP055 | 149,00 |
| RC250/390 | left side - lato SX | 2017 | 2020 | CP088 | 198,00 |
| RC250/390 | full kit - kit completo | 2017 | 2020 | CP089 | 347,00 |
| 790 Duke | right side (water pump) lato DX (pompa acqua.) | 2018 | 2020 | CP090 | 94,00 |
| 790 Duke | right side (clutch) - lato DX (frizione) | 2018 | 2020 | CP091 | 124,00 |
| 790 Duke | left side - lato SX | 2018 | 2020 | CP092 | 143,00 |
| 790 Duke | full kit - kit completo | 2018 | 2020 | CP093 | 359,00 |
| 890 Duke / 890 Duke R | right side (water pump) lato DX (pompa acqua.) | 2020 | > | CP090 | 94,00 |
| 890 Duke / 890 Duke R | right side (clutch) - lato DX (frizione) | 2020 | > | CP091B | 124,00 |
| 890 Duke / 890 Duke R | left side - lato SX | 2020 | > | CP092B | 143,00 |
| 890 Duke / 890 Duke R | full kit - kit completo | 2020 | > | CP093B | 359,00 |
| 1290 Superduke | right side - lato DX | 2013 | 2019 | CP058 | 143,00 |
| 1290 Superduke | left side - lato SX | 2013 | 2019 | CP059 | 186,00 |
| 1290 Superduke | full kit - kit completo | 2013 | 2019 | CP060 | 328,00 |
| 1290 Superduke R | right side - lato DX | 2020 | > | CP058 | 143,00 |
| 1290 Superduke R | left side - lato SX | 2020 | > | CP059 | 186,00 |
| 1290 Superduke R | full kit - kit completo | 2020 | > | CP060 | 328,00 |



KAWASAKI ZX-10R - full kit - kit completo - cod. CP012



KTM 790 DUKE - full kit - kit completo - cod. CP093



Kawasaki ZX-10R (2011/>)
code CP012

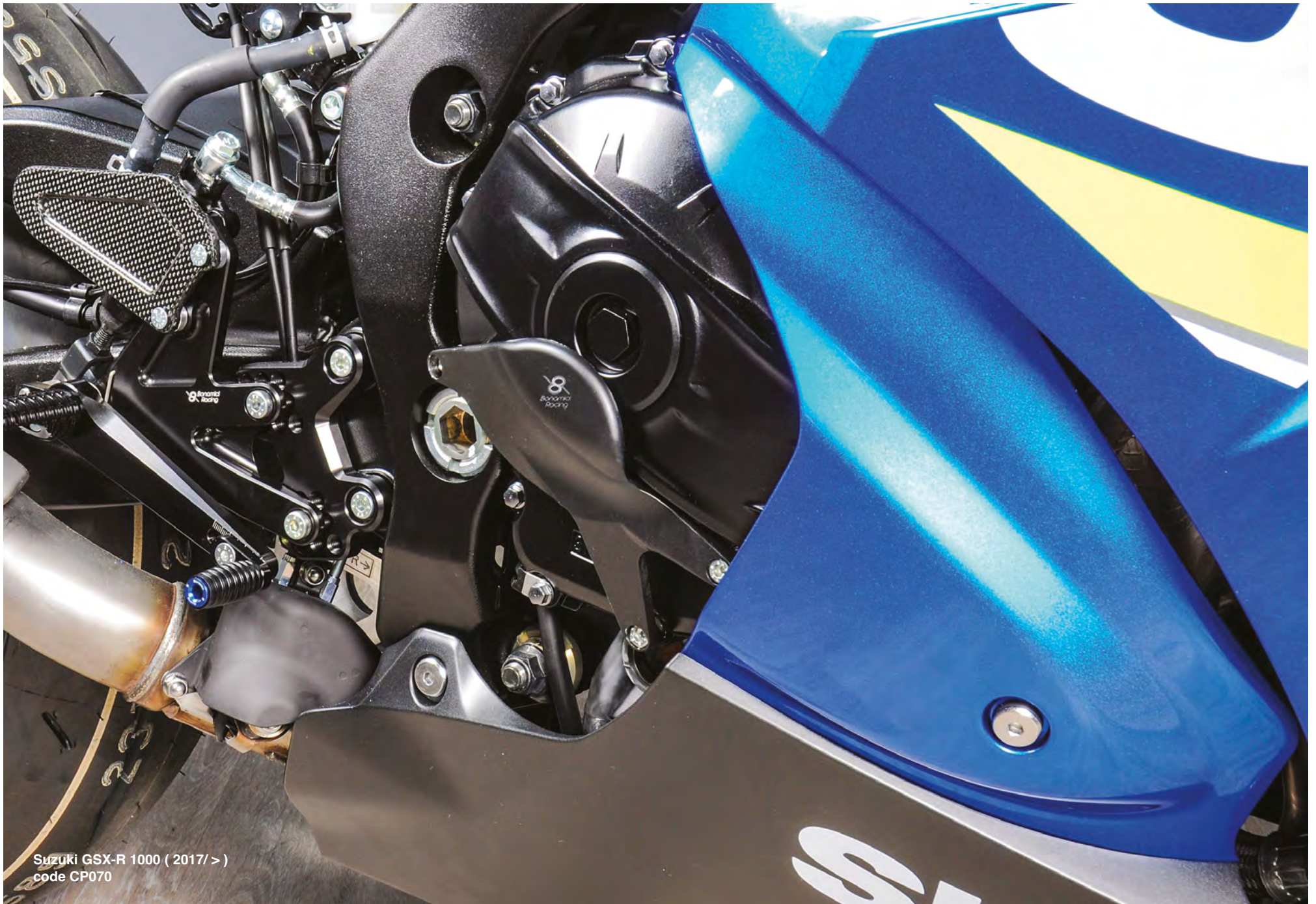

Suzuki GSX-R 1000 (2017/ >)
code CP070

MV AGUSTA



MV AGUSTA - full kit - kit completo - cod. CP021

| MODEL - MODELLO | DESCRIPTION - DESCRIZIONE | FROM - DAL | TO - AL | CODE - CODICE | € |
|-------------------------|---------------------------|------------|---------|---------------|--------|
| F3 - Brutale 675/800 | right side - lato DX | 2010 | 2019 | CP019 | 174,00 |
| F3 - Brutale 675/800 | left side - lato SX | 2010 | 2019 | CP020 | 137,00 |
| F3 - Brutale 675/800 | full kit - kit completo | 2010 | 2019 | CP021 | 310,00 |
| F4 - Brutale 990/1090 * | right side - lato DX | 2010 | 2019 | CP016 | 180,00 |
| F4 - Brutale 990/1090 * | left side - lato SX | 2010 | 2019 | CP017 | 56,00 |
| F4 - Brutale 990/1090 * | full kit - kit completo | 2010 | 2019 | CP018 | 235,00 |

SUZUKI



SUZUKI GSX-R 1000 - full kit - kit completo - cod. CP070

| MODEL - MODELLO | DESCRIPTION - DESCRIZIONE | FROM - DAL | TO - AL | CODE - CODICE | € |
|-----------------|--------------------------------------------|------------|---------|---------------|--------|
| GSX-R 600/750 * | right side - lato DX | 2011 | 2017 | CP048 | 97,00 |
| GSX-R 600/750 * | left side - lato SX | 2011 | 2017 | CP049 | 174,00 |
| GSX-R 600/750 * | full kit - kit completo | 2011 | 2017 | CP050 | 270,00 |
| GSX-R 1000 * | right side - lato DX | 2009 | 2016 | CP041 | 97,00 |
| GSX-R 1000 * | left side - lato SX | 2009 | 2016 | CP042 | 174,00 |
| GSX-R 1000 * | full kit - kit completo | 2009 | 2016 | CP043 | 270,00 |
| GSX-R 1000 | right side (distrib.) - lato DX (distrib.) | 2017 | > | CP067 | 100,00 |
| GSX-R 1000 | right side (clutch) - lato DX (frizione) | 2017 | > | CP068 | 137,00 |
| GSX-R 1000 | left side - lato SX | 2017 | > | CP069 | 161,00 |
| GSX-R 1000 | full kit - kit completo | 2017 | > | CP070 | 396,00 |

TRIUMPH



TRIUMPH SEEP TRIPLE 1200 RR/RS - full kit - kit completo - cod. CP119

| MODEL - MODELLO | DESCRIPTION - DESCRIZIONE | FROM - DAL | TO - AL | CODE - CODICE | € |
|-----------------------------------|--------------------------------------------|------------|---------|---------------|--------|
| Street Triple 765 S/R/RS | right side (distrib.) - lato DX (distrib.) | 2017 | > | CP071 | 74,00 |
| Street Triple 765 S/R/RS | right side (clutch) - lato DX (frizione) | 2017 | > | CP072 | 137,00 |
| Street Triple 765 S/R/RS | left side - lato SX | 2017 | > | CP073 | 149,00 |
| Street Triple 765 S/R/RS | full kit - kit completo | 2017 | > | CP074 | 359,00 |
| NEW Speed Triple1200 RR/RS | right side - lato DX | 2021 | > | CP117 | 125,00 |
| NEW Speed Triple1200 RR/RS | left side - lato SX | 2021 | > | CP118 | 165,00 |
| NEW Speed Triple1200 RR/RS | full kit - kit completo | 2021 | > | CP119 | 290,00 |

* Available only on specific request * Disponibili solo su specifica richiesta

YAMAHA

| MODEL - MODELLO | DESCRIPTION - DESCRIZIONE | FROM - DAL | TO - AL | CODE - CODICE | € |
|-----------------|-----------------------------------------------------|------------|---------|---------------|--------|
| YZF R3 | right side (water pump) lato DX (pompa acqua.) | 2015 | > | CP051 | 80,00 |
| YZF R3 | right side (clutch) - lato DX (frizione) | 2015 | > | CP052 | 118,00 |
| YZF R3 | left side - lato SX | 2015 | > | CP053 | 161,00 |
| YZF R3 | full kit - kit completo | 2015 | > | CP054 | 359,00 |
| YZF R6 | right side (distribution) - lato DX (distribuzione) | 2006 | > | CP022 | 56,00 |
| YZF R6 | right side (clutch) - lato DX (frizione) | 2006 | > | CP023 | 180,00 |
| YZF R6 | left side - lato SX | 2006 | > | CP024 | 168,00 |
| YZF R6 | full kit - kit completo | 2006 | > | CP025 | 402,00 |
| YZF R1/R1M | right side (distribution) - lato DX (distribuzione) | 2015 | > | CP044 | 112,00 |
| YZF R1/R1M | right side (clutch) - lato DX (frizione) | 2015 | > | CP045 | 174,00 |
| YZF R1/R1M | left side - lato SX | 2015 | > | CP046 | 161,00 |
| YZF R1/R1M | full kit - kit completo | 2015 | > | CP047 | 445,00 |
| MT-10 | right side (distribution) - lato DX (distribuzione) | 2016 | > | CP044 | 112,00 |
| MT-10 | right side (clutch) - lato DX (frizione) | 2016 | > | CP045 | 174,00 |
| MT-10 | left side - lato SX | 2016 | > | CP061 | 161,00 |
| MT-10 | full kit - kit completo | 2016 | > | CP062 | 445,00 |



YAMAHA YZF R3 - full kit - kit completo - cod. CP054



YAMAHA YZF R6 - full kit - kit completo - cod. CP025



Yamaha YZF R1/R1 (2015/>)
code CP047



YAMAHA YZF R1/R1M - full kit - kit completo - cod. CP047



Yamaha YZF R1/R1 (2015 / >)
code CP047

ENGINE PROTECTIONS ACCESSORIES - ACCESSORI PROTEZIONI MOTORE

| DESCRIPTION - DESCRIZIONE | CODE - CODICE | € |
|-------------------------------------------------------------------------------|---------------|-------|
| Laser engravings (kit - 2 engravings) Incisioni laser (kit - 2 incisioni) | KK04P | 25,00 |
| Extra colour (kit) (*) - Colore extra (kit)(*) | KK07P | 40,00 |

PRICES WITHOUT VAT - PREZZI IVA ESCLUSA



Bronze



Silver



Gold



Orange



Red



Green



Blue



WARNING
ATTENZIONE

(*) Available only by purchasing a new kit

(*) Disponibile solo durante l'acquisto di kit nuovo



Our dash protection, news of 2019, born from the strong demand on racing protect the latest generation displays, sophisticated and precious devices. Made from special aluminum who can absorb shocks, with cnc machining, are resistant and safe, in addition, are equipped with an interchangeable Plexiglas protective panel with anti-fog system. Standard color black or silver, other colors on request.

Le protezioni strumentazione, prodotto novità 2019, nascono direttamente dall'uso agonistico per proteggere i display di ultima generazione, veri computer sofisticati e preziosi. Realizzate in alluminio con lavorazione cnc, sono resistentissime e dotate di un pannello protettivo in plexiglas intercambiabile con sistema antiappannamento. Colore standard nero, su richiesta è possibile averle in altri colori.



Ducati Streetfighter V4 (2020/ >)
code DCP10

Honda CBR1000RR-R Fireblade (2020 / >)
code DCP09



DUCATI PANIGALE V4 - cod. DCP03



BMW S 1000 RR / M1000RR / S 1000 R / S 1000 XR - cod. DCP08



HONDA CBR1000RR-R FIREBLADE - cod. DCP09

DASHBOARD PROTECTIONS - PROTEZIONI STRUMENTAZIONE

| BRAND | MODEL - MODELLO | FROM - DAL | TO - AL | CODE - CODICE | € |
|---------------------|---------------------------|------------|---------|---------------|--------|
| Aprilia | RS 660 - TUONO 660 | 2020 | > | DCP12 | 191,00 |
| Aprilia | RSV4 Factory / TUONO V4 | 2021 | > | DCP13 | 191,00 |
| Aprilia | RSV4 / TUONO V4 | 2017 | 2020 | DCP06 | 191,00 |
| BMW | S 1000 RR - M 1000 RR | 2019 | > | DCP08 | 191,00 |
| BMW | S 1000 R | 2021 | > | DCP08 | 191,00 |
| BMW | S 1000 XR | 2020 | > | DCP08 | 191,00 |
| Ducati | Panigale V2 | 2020 | > | DCP11 | 179,00 |
| Ducati | Panigale V4 / V4S / V4R | 2017 | > | DCP03 | 179,00 |
| Ducati | Streetfighter V4 / V4S | 2020 | > | DCP10 | 179,00 |
| Honda | CBR 1000 RR-R Fireblade | 2020 | > | DCP09 | 182,00 |
| NEW Kawasaki | ZX-10R | 2021 | > | DCP20 | 206,00 |
| Suzuki | GSX-R 1000 | 2017 | > | DCP05 | 191,00 |
| Suzuki | GSX-S 1000 | 2021 | > | DCP05 | 191,00 |
| Yamaha | YZF R3* | 2019 | > | DCP07 | 179,00 |
| Yamaha | YZF R1 / R1M | 2015 | > | DCP04 | 179,00 |
| Yamaha | YZF R7 | 2021 | > | DCP16 | 184,00 |
| 2D | - | - | - | DCP01 | 191,00 |
| I2M | Chrome lite - Chrome plus | - | - | DCP02 | 184,00 |
| NEW I2M | Chrome PRO 2 | - | - | DCP19 | 184,00 |
| ECUMASTER | ADU5 | - | 2020 | DCP14 | 230,00 |
| ECUMASTER | ADU5 | 2021 | > | DCP15 | 230,00 |
| Aim | MXm | - | - | DCP17 | 179,00 |
| NEW Aim | Solo 2 - Solo 2 DL | - | - | DCP18 | 140,00 |

SCREEN SPARE PART - VETRINO DI RICAMBIO

| BRAND | MODEL - MODELLO | FROM - DAL | TO - AL | CODE - CODICE | € |
|---------------------|---------------------------|------------|---------|---------------|-------|
| Aprilia | RS 660 | 2020 | > | SP_DCP12 | 19,00 |
| Aprilia | RSV4 Factory / Tuono V4 | 2021 | > | SP_DCP13 | 19,00 |
| Aprilia | RSV4 / Tuono V4 | 2017 | 2020 | SP_DCP06 | 19,00 |
| BMW | S 1000 RR - M 1000 RR | 2019 | > | SP_DCP08 | 32,00 |
| BMW | S 1000 R | 2021 | > | SP_DCP08 | 32,00 |
| BMW | S 1000 XR | 2020 | > | SP_DCP08 | 32,00 |
| Ducati | Panigale V2 | 2020 | > | SP_DCP11 | 19,00 |
| Ducati | Panigale V4 / V4S / V4R | 2017 | > | SP_DCP03 | 19,00 |
| Ducati | Streetfighter V4 / V4S | 2020 | > | SP_DCP10 | 19,00 |
| Honda | CBR 1000 RR-R Fireblade | 2020 | > | SP_DCP09 | 19,00 |
| NEW Kawasaki | ZX-10R | 2021 | > | SP_DCP20 | 19,00 |
| Suzuki | GSX-R 1000 | 2017 | > | SP_DCP05 | 19,00 |
| Suzuki | GSX-S 1000 | 2021 | > | SP_DCP05 | 19,00 |
| Yamaha | YZF R3* | 2019 | > | SP_DCP07 | 19,00 |
| Yamaha | YZF R1 / R1M | 2015 | > | SP_DCP04 | 19,00 |
| Yamaha | YZF R7 | 2021 | > | SP_DCP16 | 19,00 |
| 2D | - | - | - | SP_DCP01 | 19,00 |
| I2M | Chrome lite - Chrome plus | - | - | SP_DCP02 | 19,00 |
| NEW I2M | Chrome PRO 2 | - | - | SP_DCP19 | 19,00 |
| ECUMASTER | ADU5 | - | 2020 | SP_DCP14 | 19,00 |
| ECUMASTER | ADU5 | 2021 | > | SP_DCP15 | 19,00 |
| Aim | MXm | - | - | SP_DCP17 | 19,00 |
| NEW Aim | Solo 2 - Solo 2 DL | - | - | SP_DCP18 | 19,00 |

Colors available - Colori disponibili

Black



WARNING ATTENZIONE

(*) It's possible to mount only with racing fairing - (*) Si può montare solo con le carene racing



APRILIA RSV4 FACTORY / TUONO V4 (2021) - cod. DCP06



Aim MXm - cod. DCP17



Aim Solo2 - cod. DCP18

TOP TRIPLE CLAMP - PIASTRE DI STERZO SUPERIORI

TOP TRIPLE CLAMP STREET VERSION
PIASTRE DI STERZO SUPERIORI VERSIONE STREET



TOP TRIPLE CLAMP RACE VERSION
PIASTRE DI STERZO SUPERIORI VERSIONE RACE

The range of top triple clamps is part of Bonamici Racing innovations for 2019 and stems from the experience gained in international competitions with high-level teams.

Made from solid billet aluminum with numerical control machines, with a modern and appealing design, they are the ideal product to improve performance and driving pleasure without increasing weight.

Two types: "Race" for use on the racetrack "Street" for the assembly of the original ignition block (where provided), no modification or adaptation is required on the stock-bike for assembly.

La gamma di piastre di sterzo superiori fa parte delle novità Bonamici Racing per il 2019 e nascono dall'esperienza maturata nelle competizioni mondiali in team di alto livello.

Realizzate in alluminio con lavorazione cnc, con un disegno moderno ed accattivante, sono il prodotto ideale per migliorare le performance ed il piacere di guida senza incrementare il peso. Due le tipologie: "Race" per l'impiego in pista e "Street" per il montaggio del blocchetto accensione originale (dove previsto), per il montaggio non è richiesta alcuna modifica o adattamento sulla moto di serie.



YAMAHA YZF R7 (2021/>)
code PSY3



TRIUMPH SPEED TRIPLE 1200 RR (2022/>) - code PST1

TOP TRIPLE CLAMP - PIASTRE DI STERZO SUPERIORI

| BRAND | MODEL - MODELLO | FROM - DAL | TO - AL | CODE - CODICE | € |
|---------|------------------------------|------------|---------|---------------|--------|
| Aprilia | RS 660 | 2020 | > | PSA2 | 478,00 |
| Aprilia | RSV4 - RSV4 Factory "Street" | 2009 | 2014 | PSA1 | 406,00 |
| | | 2019 | > | | |
| Aprilia | RSV4 - RSV4 Factory "Race" * | 2009 | 2014 | PSA1R | 332,00 |
| | | 2019 | > | | |
| BMW | S 1000 RR "Street" | 2015 | 2018 | PSB1 | 401,00 |
| BMW | S 1000 RR "Race" * | 2015 | 2018 | PSB1R | 332,00 |
| BMW | S 1000 RR "Street" | 2019 | > | PSB2 | 401,00 |
| BMW | S 1000 RR "Race" * | 2019 | > | PSB2R | 332,00 |
| BMW | M 1000 RR "Street" | 2021 | > | PSB3 | 401,00 |
| BMW | M 1000 RR "Race" * | 2021 | > | PSB3R | 332,00 |
| Ducati | Panigale V2 | 2020 | > | PSV2 | 501,00 |
| Ducati | Panigale V4/V4S/V4R | 2018 | > | PSV4 | 501,00 |
| Honda | CBR 1000 RR "Street" | 2017 | 2019 | PSH1 | 457,00 |
| Honda | CBR 1000 RR "Race" * | 2017 | 2019 | PSH1R | 332,00 |
| Honda | CBR 1000RR-R Fireblade | 2020 | > | PSH2 | 478,00 |



- Titanium tightening screws on the forks
- Viti di serraggio sulle forcelle in titanio

| BRAND | MODEL - MODELLO | FROM - DAL | TO - AL | CODE - CODICE | € |
|--------------------|-------------------------|------------|---------|---------------|--------|
| Kawasaki | ZX-10R "Street" | 2016 | > | PSK1 | 379,00 |
| Kawasaki | ZX-10R "Race" * | 2016 | > | PSK1R | 356,00 |
| Suzuki | GSX-R 1000 "Street" | 2017 | > | PSS1 | 379,00 |
| Suzuki | GSX-R 1000 "Race" * | 2017 | > | PSS1R | 332,00 |
| NEW Triumph | Speed Triple 1200 RR ** | 2022 | > | PST1 | 478,00 |
| Yamaha | YZF R6 "Street" | 2017 | > | PSY2 | 379,00 |
| Yamaha | YZF R6 "Race" * | 2017 | > | PSY2R | 332,00 |
| Yamaha | YZF R1/R1M "Street" | 2015 | > | PSY1 | 379,00 |
| Yamaha | YZF R1/R1M "Race" * | 2015 | > | PSY1R | 332,00 |
| Yamaha | YZF R7 "Street" | 2021 | > | PSY3 | 379,00 |
| Yamaha | YZF R7 "Race" * | 2021 | > | PSY3R | 346,00 |

WARNING ATTENZIONE

(*) is not possible to mount the OEM ignition switch key
 (*) non è possibile rimontare il blocchetto accensione originale racing
 (**) Equipped with the top tripleclamp plate nut, it is recommended to apply a light layer of grease when fitting the nut
 (**) Dotata del dado della piastra di sterzo, si consiglia al momento del montaggio del dado di applicare un leggero strato di grasso



Colors available - Colori disponibili



APRILIA RSV4 "STREET" - cod. PSA1



DUCATI PANIGALE V4 -V4S-V4R - cod. PSV4



HONDA CBR1000RR-R FIREBLADE - cod. PSH2



The new range of brake and clutch lever controls has been redesigned to offer a better feeling of riding with your bike. Made of aluminum machined from solid with foldable lever, are equipped with a hole for air outflow who prevents the actuation if subject to the aerodynamic force. The new levers are more resistant and offer even more precise adjustment, moreover they have more excursion in order to adapt to any type of use. The final tilting part have a shape designed to offer the best grip and ergonomics. More shapes are available on request to satisfy every driving style.

La nuova gamma di comandi leva per freno e frizione è stata riprogettata per offrire un maggior feeling di guida con la propria moto. Realizzate in alluminio ricavate dal pieno con leva ribaltabile, sono dotate di foro per il deflusso aerodinamico che impedisce l'azionamento se soggette alla forza dell'aria. Le nuove leve sono più resistenti ed offrono una regolazione ancora più precisa e con più escursione in modo da adattarsi ad ogni tipo di utilizzo. Hanno inoltre la parte ribaltabile con una forma studiata per offrire la migliore presa ed ergonomia e sono disponibili su richiesta altre forme in modo da soddisfare ogni stile di guida.



APRILIA

| MODEL - MODELLO | DESCRIPTION - DESCRIZIONE | FROM - DAL | TO - AL | CODE - CODICE | € |
|-----------------------|------------------------------|------------|---------|---------------|--------|
| RSV4 - Factory - APRC | Levers kit - Kit leve | 2009 | > | KL010 | 247,00 |
| RSV4 - Factory - APRC | Brake lever - Leva freno | 2009 | > | LB110 | 146,00 |
| RSV4 - Factory - APRC | Clutch lever - Leva frizione | 2009 | > | LC010 | 116,00 |
| Tuono 1100 | Levers kit - Kit leve | 2017 | 2020 | KL010 | 247,00 |
| Tuono 1100 | Brake lever - Leva freno | 2017 | 2020 | LB110 | 146,00 |
| Tuono 1100 | Clutch lever - Leva frizione | 2017 | 2020 | LC010 | 116,00 |
| RS 660 - TUONO 660 | Levers kit - Kit leve | 2020 | > | KL010 | 247,00 |
| RS 660 - TUONO 660 | Brake lever - Leva freno | 2020 | > | LB110 | 146,00 |
| RS 660 - TUONO 660 | Clutch lever - Leva frizione | 2020 | > | LC010 | 116,00 |



APRILIA RSV4 - FACTORY - APRC - Levers kit - Kit leve - cod. KL010

BMW

| MODEL - MODELLO | DESCRIPTION - DESCRIZIONE | FROM - DAL | TO - AL | CODE - CODICE | € |
|-----------------------|-----------------------------------------------------------------------------------------------------------------------------------------------------------------------------|------------|---------|---------------|--------|
| S 1000 RR - HP4 | Levers kit - Kit leve | 2008 | 2014 | KL020 | 247,00 |
| S 1000 RR - HP4 | Brake lever - Leva freno | 2008 | 2014 | LB090 | 146,00 |
| S 1000 RR - HP4 | Clutch lever - Leva frizione | 2008 | 2014 | LC070 | 116,00 |
| S 1000 RR | Levers kit - Kit leve | 2015 | 2018 | KL220 | 260,00 |
| S 1000 RR | Brake lever - Leva freno | 2015 | 2018 | LB090 | 146,00 |
| S 1000 RR | Clutch lever - Leva frizione | 2015 | 2018 | LC140 | 130,00 |
| S 1000 RR - M 1000 RR | Levers kit - Kit leve | 2019 | > | KL290 | 260,00 |
| S 1000 RR - M 1000 RR | Brake lever - Leva freno | 2019 | > | LB090 | 146,00 |
| S 1000 RR - M 1000 RR | Clutch lever - Leva frizione The plastic protection cannot be remounted on the clutch lever. Non è possibile rimontare la protezione in plastica sulla leva frizione. | 2019 | > | LC170 | 130,00 |
| S 1000 R | Levers kit - Kit leve | 2012 | 2020 | KL220 | 260,00 |
| S 1000 R | Brake lever - Leva freno | 2012 | 2020 | LB090 | 146,00 |
| S 1000 R | Clutch lever - Leva frizione | 2012 | 2020 | LC140 | 130,00 |
| S 1000 R | Levers kit - Kit leve | 2021 | > | KL270 | 260,00 |
| S 1000 R | Brake lever - Leva freno | 2021 | > | LB200 | 146,00 |
| S 1000 R | Clutch lever - Leva frizione The plastic protection cannot be remounted on the clutch lever. Non è possibile rimontare la protezione in plastica sulla leva frizione. | 2021 | > | LC170 | 130,00 |
| S 1000 XR | Levers kit - Kit leve | 2020 | > | KL270 | 260,00 |
| S 1000 XR | Brake lever - Leva freno | 2020 | > | LB200 | 146,00 |
| S 1000 XR | Clutch lever - Leva frizione The plastic protection cannot be remounted on the clutch lever. Non è possibile rimontare la protezione in plastica sulla leva frizione. | 2020 | > | LC170 | 130,00 |



BMW S 1000 RR (2019) - Levers kit - Kit leve - cod. KL290



BMW S 1000 R (2021) - Levers kit - Kit leve - cod. KL270



BMW S 1000 RR (2019/>)
code KL290

Ducati Streetfighter V4 (2020/>)
code KL031



DUCATI



● **DUCATI Levers kit - Kit leve** - cod. KL031



Multistrada V4 (2020/>)
code KL031



Multistrada V4 (2020/>)
code KL031

| MODEL - MODELLO | DESCRIPTION - DESCRIZIONE | FROM - DAL | TO - AL | CODE - CODICE | € |
|---------------------------------------------------|------------------------------|------------|---------|---------------|--------|
| Monster 1100 | Levers kit - Kit leve | 2010 | 2016 | KL031 | 273,00 |
| Monster 1100 | Brake lever - Leva freno | 2010 | 2016 | LB140 | 146,00 |
| Monster 1100 | Clutch lever - Leva frizione | 2010 | 2016 | LC061 | 143,00 |
| Monster 1200 | Levers kit - Kit leve | 2014 | 2018 | KL031 | 273,00 |
| Monster 1200 | Brake lever - Leva freno | 2014 | 2018 | LB140 | 146,00 |
| Monster 1200 | Clutch lever - Leva frizione | 2014 | 2018 | LC061 | 143,00 |
| 749/999 | Levers kit - Kit leve | 2002 | 2006 | KL031 | 273,00 |
| 749/999 | Brake lever - Leva freno | 2002 | 2006 | LB140 | 146,00 |
| 749/999 | Clutch lever - Leva frizione | 2002 | 2006 | LC061 | 143,00 |
| 848/1098/1198 | Levers kit - Kit leve | 2007 | 2012 | KL031 | 273,00 |
| 848/1098/1198 | Brake lever - Leva freno | 2007 | 2012 | LB140 | 146,00 |
| 848/1098/1198 | Clutch lever - Leva frizione | 2007 | 2012 | LC061 | 143,00 |
| Panigale V2 899 - 959 - 1199 - 1299 Panigale | Levers kit - Kit leve | 2012 | > | KL031 | 273,00 |
| Panigale V2 899 - 959 - 1199 - 1299 Panigale | Brake lever - Leva freno | 2012 | > | LB140 | 146,00 |
| Panigale V2 899 - 959 - 1199 - 1299 Panigale | Clutch lever - Leva frizione | 2012 | > | LC061 | 143,00 |
| Panigale V4 / V4S / V4R | Levers kit - Kit leve | 2018 | > | KL031 | 273,00 |
| Panigale V4 / V4S / V4R | Brake lever - Leva freno | 2018 | > | LB140 | 146,00 |
| Panigale V4 / V4S / V4R | Clutch lever - Leva frizione | 2018 | > | LC061 | 143,00 |
| Streetfighter 848 / 1100 | Levers kit - Kit leve | 2009 | 2016 | KL031 | 273,00 |
| Streetfighter 848 / 1100 | Brake lever - Leva freno | 2009 | 2016 | LB140 | 146,00 |
| Streetfighter 848 / 1100 | Clutch lever - Leva frizione | 2009 | 2016 | LC061 | 143,00 |
| Streetfighter V4 / V4S | Levers kit - Kit leve | 2020 | > | KL031 | 273,00 |
| Streetfighter V4 / V4S | Brake lever - Leva freno | 2020 | > | LB140 | 146,00 |
| Streetfighter V4 / V4S | Clutch lever - Leva frizione | 2020 | > | LC061 | 143,00 |
| Multistrada 1200 | Levers kit - Kit leve | 2015 | 2019 | KL031 | 273,00 |
| Multistrada 1200 | Brake lever - Leva freno | 2015 | 2019 | LB140 | 146,00 |
| Multistrada 1200 | Clutch lever - Leva frizione | 2015 | 2019 | LC061 | 143,00 |
| Multistrada V2 / V2S | Levers kit - Kit leve | 2021 | > | KL031 | 273,00 |
| Multistrada V2 / V2S | Brake lever - Leva freno | 2021 | > | LB140 | 146,00 |
| Multistrada V2 / V2S | Clutch lever - Leva frizione | 2021 | > | LC061 | 143,00 |
| Multistrada V4 V4S / V4S Sport / V4 Pikes Peak | Levers kit - Kit leve | 2020 | > | KL031 | 273,00 |
| Multistrada V4 V4S / V4S Sport / V4 Pikes Peak | Brake lever - Leva freno | 2020 | > | LB140 | 146,00 |
| Multistrada V4 V4S / V4S Sport / V4 Pikes Peak | Clutch lever - Leva frizione | 2020 | > | LC061 | 143,00 |

HONDA

| MODEL - MODELLO | DESCRIPTION - DESCRIZIONE | FROM - DAL | TO - AL | CODE - CODICE | € |
|----------------------------|------------------------------|------------|---------|---------------|--------|
| CBR 500 R - CB 500 F | Levers kit - Kit leve | 2019 | > | KL350 | 247,00 |
| CBR 500 R - CB 500 F | Brake lever - Leva freno | 2019 | > | LB180 | 146,00 |
| CBR 500 R - CB 500 F | Clutch lever - Leva frizione | 2019 | > | LC220 | 116,00 |
| CBR 600 RR | Levers kit - Kit leve | 2007 | > | KL040 | 247,00 |
| CBR 600 RR | Brake lever - Leva freno | 2007 | > | LB150 | 146,00 |
| CBR 600 RR | Clutch lever - Leva frizione | 2007 | > | LC020 | 116,00 |
| CBR 1000 RR | Levers kit - Kit leve | 2008 | 2019 | KL040 | 247,00 |
| CBR 1000 RR | Brake lever - Leva freno | 2008 | 2019 | LB150 | 146,00 |
| CBR 1000 RR | Clutch lever - Leva frizione | 2008 | 2019 | LC020 | 116,00 |
| CBR 1000 RR-R Fireblade | Levers kit - Kit leve | 2020 | > | KL040 | 247,00 |
| CBR 1000 RR-R Fireblade | Brake lever - Leva freno | 2020 | > | LB150 | 146,00 |
| CBR 1000 RR-R Fireblade | Clutch lever - Leva frizione | 2020 | > | LC020 | 116,00 |
| CBR 1000 RR-R Fireblade SP | Levers kit - Kit leve | 2020 | > | KL310 | 247,00 |
| CBR 1000 RR-R Fireblade SP | Brake lever - Leva freno | 2020 | > | LB110 | 146,00 |
| CBR 1000 RR-R Fireblade SP | Clutch lever - Leva frizione | 2020 | > | LC020 | 116,00 |



HONDA CBR1000RR-R FIREBLADE SP
Levers kit - Kit leve - cod. KL310



Honda CBR1000RR-R Fireblade (2020/21)
code KL040

KAWASAKI



KAWASAKI NINJA 250/400
Levers kit - Kit leve - cod. KL260



KAWASAKI ZX-10R (2016 ->)
Levers kit - Kit leve - cod. KL210



KTM 790 DUKE - Levers kit - Kit leve - cod. KL300

| MODEL - MODELLO | DESCRIPTION - DESCRIZIONE | FROM - DAL | TO - AL | CODE - CODICE | € |
|-------------------|------------------------------|------------|---------|---------------|--------|
| Ninja 300 (ZX-3R) | Levers kit - Kit leve | 2014 | 2017 | KL260 | 247,00 |
| Ninja 300 (ZX-3R) | Brake lever - Leva freno | 2014 | 2017 | LB180 | 146,00 |
| Ninja 300 (ZX-3R) | Clutch lever - Leva frizione | 2014 | 2017 | LC160 | 116,00 |
| Ninja 250/400 | Levers kit - Kit leve | 2018 | > | KL260 | 247,00 |
| Ninja 250/400 | Brake lever - Leva freno | 2018 | > | LB180 | 146,00 |
| Ninja 250/400 | Clutch lever - Leva frizione | 2018 | > | LC160 | 116,00 |
| ZX-6R - ZX-6R 636 | Levers kit - Kit leve | 2005 | 2017 | KL110 | 247,00 |
| ZX-6R - ZX-6R 636 | Brake lever - Leva freno | 2005 | 2017 | LB160 | 146,00 |
| ZX-6R - ZX-6R 636 | Clutch lever - Leva frizione | 2005 | 2017 | LC040 | 116,00 |
| ZX-10R | Levers kit - Kit leve | 2006 | 2015 | KL110 | 247,00 |
| ZX-10R | Brake lever - Leva freno | 2006 | 2015 | LB160 | 146,00 |
| ZX-10R | Clutch lever - Leva frizione | 2006 | 2015 | LC040 | 116,00 |
| ZX-10R | Levers kit - Kit leve | 2016 | > | KL210 | 247,00 |
| ZX-10R | Brake lever - Leva freno | 2016 | > | LB110 | 146,00 |
| ZX-10R | Clutch lever - Leva frizione | 2016 | > | LC040 | 116,00 |

KTM

| MODEL - MODELLO | DESCRIPTION - DESCRIZIONE | FROM - DAL | TO - AL | CODE - CODICE | € |
|------------------|------------------------------|------------|---------|---------------|--------|
| 790/890 Duke | Levers kit - Kit leve | 2018 | > | KL300 | 260,00 |
| 790/890 Duke | Brake lever - Leva freno | 2018 | > | LB190 | 146,00 |
| 790/890 Duke | Clutch lever - Leva frizione | 2018 | > | LC180 | 130,00 |
| 890 Duke R | Levers kit - Kit leve | 2021 | > | KL320 | 246,00 |
| 890 Duke R | Brake lever - Leva freno | 2021 | > | LB210 | 116,00 |
| 890 Duke R | Clutch lever - Leva frizione | 2021 | > | LC180 | 130,00 |
| 1290 Superduke R | Levers kit - Kit leve | 2020 | > | KL280 | 260,00 |
| 1290 Superduke R | Brake lever - Leva freno | 2020 | > | LB110 | 146,00 |
| 1290 Superduke R | Clutch lever - Leva frizione | 2020 | > | LC200 | 130,00 |



Kawasaki Ninja 250/400 (2018/>)
code KL260



Triumph Speed Triple 1200 RR (2022/ >) - code KL360

MV AGUSTA



● MV AGUSTA F3 675 / F3 800 - *Levers kit - Kit leve* - cod. KL200

| MODEL - MODELLO | DESCRIPTION - DESCRIZIONE | FROM - DAL | TO - AL | CODE - CODICE | € |
|-----------------|------------------------------|------------|---------|---------------|--------|
| F3 675/ F3 800 | Levers kit - Kit leve | 2011 | > | KL200 | 247,00 |
| F3 675/ F3 800 | Brake lever - Leva freno | 2011 | > | LB090 | 146,00 |
| F3 675/ F3 800 | Clutch lever - Leva frizione | 2011 | > | LC110 | 116,00 |

SUZUKI



● SUZUKI GSX-R 1000 - *Levers kit - Kit leve* - cod. KL170

| MODEL - MODELLO | DESCRIPTION - DESCRIZIONE | FROM - DAL | TO - AL | CODE - CODICE | € |
|----------------------|------------------------------|------------|---------|---------------|--------|
| GSX-R 600/ GSX-R 750 | Levers kit - Kit leve | 2006 | 2010 | KL120 | 247,00 |
| GSX-R 600/ GSX-R 750 | Brake lever - Leva freno | 2006 | 2010 | LB090 | 146,00 |
| GSX-R 600/ GSX-R 750 | Clutch lever - Leva frizione | 2006 | 2010 | LC010 | 116,00 |
| GSX-R 600/ GSX-R 750 | Levers kit - Kit leve | 2011 | 2017 | KL170 | 247,00 |
| GSX-R 600/ GSX-R 750 | Brake lever - Leva freno | 2011 | 2017 | LB090 | 146,00 |
| GSX-R 600/ GSX-R 750 | Clutch lever - Leva frizione | 2011 | 2017 | LC090 | 116,00 |
| GSX-R 1000 | Levers kit - Kit leve | 2005 | 2006 | KL120 | 247,00 |
| GSX-R 1000 | Brake lever - Leva freno | 2005 | 2006 | LB090 | 146,00 |
| GSX-R 1000 | Clutch lever - Leva frizione | 2005 | 2006 | LC010 | 116,00 |
| GSX-R 1000 | Levers kit - Kit leve | 2009 | 2010 | KL120 | 247,00 |
| GSX-R 1000 | Brake lever - Leva freno | 2009 | 2010 | LB090 | 146,00 |
| GSX-R 1000 | Clutch lever - Leva frizione | 2009 | 2010 | LC010 | 116,00 |
| GSX-R 1000 | Levers kit - Kit leve | 2011 | > | KL170 | 247,00 |
| GSX-R 1000 | Brake lever - Leva freno | 2011 | > | LB090 | 146,00 |
| GSX-R 1000 | Clutch lever - Leva frizione | 2011 | > | LC090 | 116,00 |
| GSX-S 1000 | Levers kit - Kit leve | 2021 | > | KL330 | 247,00 |
| GSX-S 1000 | Brake lever - Leva freno | 2021 | > | LB201 | 146,00 |
| GSX-S 1000 | Clutch lever - Leva frizione | 2021 | > | LC210 | 116,00 |

TRIUMPH



● TRIUMPH SPEED TRIPLE 1200 RR/RS - *Levers kit - Kit leve* - cod. KL360

| MODEL - MODELLO | DESCRIPTION - DESCRIZIONE | FROM - DAL | TO - AL | CODE - CODICE | € |
|------------------------------------|------------------------------|------------|---------|---------------|--------|
| Daytona 675 R | Levers kit - Kit leve | 2011 | 2016 | KL180 | 247,00 |
| Daytona 675 R | Brake lever - Leva freno | 2011 | 2016 | LB110 | 146,00 |
| Daytona 675 R | Clutch lever - Leva frizione | 2011 | 2016 | LC080 | 116,00 |
| Daytona 675 | Clutch lever - Leva frizione | 2011 | 2016 | LC080 | 116,00 |
| Speed Triple 1050/1050 R | Levers kit - Kit leve | 2011 | 2017 | KL180 | 247,00 |
| Speed Triple 1050/1050 R | Brake lever - Leva freno | 2011 | 2017 | LB110 | 146,00 |
| Speed Triple 1050/1050 R | Clutch lever - Leva frizione | 2011 | 2017 | LC080 | 116,00 |
| NEW Speed Triple 1200 RR/RS | Levers kit - Kit leve | 2021 | > | KL360 | 221,00 |
| Speed Triple 1200 RR/RS | Brake lever - Leva freno | 2021 | > | LB210 | 116,00 |
| NEW Speed Triple 1200 RR/RS | Clutch lever - Leva frizione | 2021 | > | LC230 | 116,00 |

YAMAHA

| MODEL - MODELLO | DESCRIPTION - DESCRIZIONE | FROM - DAL | TO - AL | CODE - CODICE | € |
|-----------------|-------------------------------------------------------------------------------------------------------------------------------------------------------------------------------------------------------------------------------------------------------------------------------------------------------------------------------------------|------------|---------|---------------|--------|
| YZF R3 | Levers kit - Kit leve | 2015 | > | KL250 | 247,00 |
| YZF R3 | Brake lever - Leva freno | 2015 | > | LB170 | 146,00 |
| YZF R3 | Clutch lever - Leva frizione | 2015 | > | LC150 | 116,00 |
| YZF R6 | Levers kit - Kit leve | 2006 | 2016 | KL240 | 247,00 |
| YZF R6 | Brake lever - Leva freno | 2006 | 2016 | LB140 | 146,00 |
| YZF R6 | Clutch lever - Leva frizione | 2006 | 2016 | LC010 | 116,00 |
| YZF R6 | Levers kit - Kit leve | 2017 | > | KL230 | 247,00 |
| YZF R6 | Brake lever - Leva freno | 2017 | > | LB100 | 146,00 |
| YZF R6 | Clutch lever - Leva frizione | 2017 | > | LC010 | 116,00 |
| YZF R1 | Levers kit - Kit leve | 2004 | 2014 | KL240 | 247,00 |
| YZF R1 | Brake lever - Leva freno | 2004 | 2014 | LB140 | 146,00 |
| YZF R1 | Clutch lever - Leva frizione | 2004 | 2014 | LC010 | 116,00 |
| YZF R1/R1M | Levers kit - Kit leve | 2015 | > | KL231 | 247,00 |
| YZF R1/R1M | Brake lever - Leva freno On this lever is not possible mount the remote adjuster. The lever with remote adjuster for YZF R1 '15/20 has code RALB100. Su questa leva non è possibile montare il registro remoto codice 00BR. L'unica leva con registro remoto utilizzabile sulla YZF R1 '15/20 è quella con codice RALB100 | 2015 | > | LB101 | 146,00 |
| YZF R1/R1M | Clutch lever - Leva frizione | 2015 | > | LC010 | 116,00 |
| YZF R7 | Levers kit - Kit leve | 2021 | > | KL340 | 272,00 |
| YZF R7 | Brake lever - Leva freno It can only be mounted on Bonamici Racing handlebars Code SM50B Può essere montata solo sui semimanubri Bonamici Racing Codice SM50B | 2021 | > | LB220 | 156,00 |
| YZF R7 | Clutch lever - Leva frizione | 2021 | > | LC010 | 116,00 |



YAMAHA YZF R6 2017 - Levers kit - Kit leve - cod. KL230



YAMAHA YZF R1/R1M - Levers kit - Kit leve - cod. KL231

BREMBO

| MODEL - MODELLO | DESCRIPTION - DESCRIZIONE | FROM - DAL | TO - AL | CODE - CODICE | € |
|-------------------|----------------------------------------------------------------------------------------------|------------|---------|---------------|--------|
| 16 X 18 - 19 X 18 | Brake lever - Leva freno | - | - | LB070 | 116,00 |
| 19 X 20 | Brake lever - Leva freno | - | - | LB080 | 116,00 |
| RCS | Brake lever - Leva freno Aluminium half lever Solo la parte terminale in alluminio | - | - | LB120 | 116,00 |
| Racing | Brake lever - Leva freno Aluminium half lever Solo la parte terminale in alluminio | - | - | LB120R | 116,00 |
| Corsa Corta | Brake lever - Leva freno Aluminium half lever Solo la parte terminale in alluminio | - | - | LB120CC | 116,00 |
| MCS | Brake lever - Leva freno | - | - | LB210 | 116,00 |



BREMBO CORSA CORTA - Brake lever - Leva freno - cod. LB120CC



Yamaha YZF R1/R1M (2015/>)
code KL231

FULL CLUTCH LEVERS - LEVE FRIZIONE COMPLETE



ADJUSTABLE - REGOLABILE

| DESCRIPTION - DESCRIZIONE | CODE - CODICE | € |
|---------------------------|---------------|--------|
| Offset 24mm | LCFR24 | 231,00 |
| Offset 29mm | LCFR29 | 231,00 |
| Offset 32mm | LCFR32 | 231,00 |
| Offset 34mm | LCFR34 | 231,00 |

NOT ADJUSTABLE - NON REGOLABILE

| DESCRIPTION - DESCRIZIONE | CODE - CODICE | € |
|---------------------------|---------------|--------|
| Offset 24mm | LCF24 | 173,00 |
| Offset 29mm | LCF29 | 173,00 |
| Offset 32mm | LCF32 | 173,00 |
| Offset 34mm | LCF34 | 173,00 |

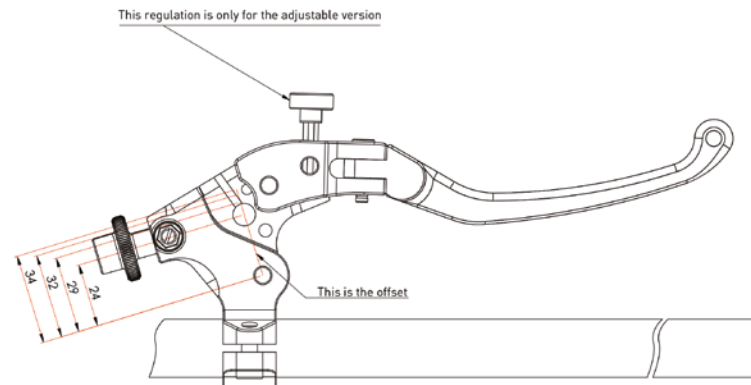

NOTES - NOTE

HOW TO CHOSE THE OFFSET

At the purchase time it is necessary to choose the ideal offset keeping in mind the following: greater is the offset, greater will be the hardness of the lever with a faster detachment. To determine the offset of the original lever, perform the measurement as in the picture.

COME SCEGLIERE L'OFFSET

Al momento dell'acquisto occorre scegliere l'offset ideale tenendo presente che maggiore è l'offset e maggiore sarà la durezza della leva con uno stacco più rapido. Per stabilire l'offset della leva originale eseguire la misurazione come in foto





BRAKE LEVERS WITH REMOTE ADJUSTER - LEVE FRENO CON REGISTRO REMOTO



BRAKE LEVERS WITH RACING REMOTE ADJUSTER
LEVE FRENO CON REGISTRO REMOTO RACING



BRAKE LEVERS WITH REMOTE ADJUSTER
LEVE FRENO CON REGISTRO REMOTO

| BRAND | MODEL - MODELLO | FROM - DAL | TO - AL | CODE - CODICE Standard version | € | CODE - CODICE Racing version | € |
|-----------|-----------------------------|------------|---------|-----------------------------------|--------|---------------------------------|--------|
| Aprilia | RS 660 - TUONO 660 | 2020 | > | RALB110 | 254,00 | RALB110R | 360,00 |
| Aprilia | RSV4 - Factory - APRC | 2009 | > | RALB110 | 254,00 | RALB110R | 360,00 |
| Aprilia | Tuono 1100 | 2017 | 2020 | RALB110 | 254,00 | RALB110R | 360,00 |
| BMW | S 1000 R | 2012 | 2020 | RALB090 | 254,00 | RALB090R | 360,00 |
| BMW | S 1000 R | 2021 | > | RALB200 | 254,00 | RALB200R | 360,00 |
| BMW | S 1000 RR - M 1000 RR - HP4 | 2008 | > | RALB090 | 254,00 | RALB090R | 360,00 |
| Ducati | 749/999 | 2002 | 2006 | RALB140 | 254,00 | RALB140R | 360,00 |
| Ducati | 848/1098/1198 | 2007 | 2012 | RALB140 | 254,00 | RALB140R | 360,00 |
| Ducati | 899/1199/1299 Panigale/V2 | 2012 | > | RALB140 | 254,00 | RALB140R | 360,00 |
| Ducati | Panigale V4/V4S/V4R | 2018 | > | RALB140 | 254,00 | RALB140R | 360,00 |
| Honda | CBR 500 R - CB 500 F | 2019 | > | RALB180 | 254,00 | RALB180R | 360,00 |
| Honda | CBR 600 RR | 2007 | > | RALB150 | 254,00 | RALB150R | 360,00 |
| Honda | CBR 1000 RR | 2004 | 2019 | RALB150 | 254,00 | RALB150R | 360,00 |
| Honda | CBR 1000 RR-R Fireblade | 2020 | > | RALB150 | 254,00 | RALB150R | 360,00 |
| Honda | CBR 1000 RR-R Fireblade SP | 2020 | > | RALB110 | 254,00 | RALB110R | 360,00 |
| Kawasaki | Ninja 300 (ZX-3R) | 2014 | 2017 | RALB180 | 254,00 | RALB180R | 360,00 |
| Kawasaki | Ninja 250/400 | 2018 | > | RALB180 | 254,00 | RALB180R | 360,00 |
| Kawasaki | ZX-6R | 2005 | 2017 | RALB160 | 254,00 | RALB160R | 360,00 |
| Kawasaki | ZX-10R | 2006 | 2015 | RALB160 | 254,00 | RALB160R | 360,00 |
| Kawasaki | ZX-10R | 2016 | > | RALB110 | 254,00 | RALB110R | 360,00 |
| KTM | 790 / 890 Duke | 2018 | > | RALB190 | 254,00 | RALB190R | 360,00 |
| KTM | 890 Duke R | 2021 | > | RALB210 | 215,00 | RALB210R | 346,00 |
| KTM | 1290 Superduke R | 2020 | > | RALB110 | 254,00 | RALB110R | 360,00 |
| MV Agusta | F3 675/800 | 2011 | > | RALB090 | 254,00 | RALB090R | 360,00 |
| Suzuki | GSX-R 600/750/1000 | 2004 | > | RALB090 | 254,00 | RALB090R | 360,00 |
| Suzuki | GSX-S 1000 | 2021 | > | RALB201 | 254,00 | RALB201R | 360,00 |
| Triumph | Daytona 675 R | 2011 | 2016 | RALB110 | 254,00 | RALB110R | 360,00 |
| Triumph | Speed triple 1200 RR/RS | 2021 | > | RALB210 | 215,00 | RALB210R | 346,00 |
| Yamaha | YZF R3 | 2015 | > | RALB170 | 254,00 | RALB170R | 360,00 |
| Yamaha | YZF R6 | 2006 | 2016 | RALB140 | 254,00 | RALB140R | 360,00 |
| Yamaha | YZF R6 | 2017 | > | RALB100 | 254,00 | RALB100R | 360,00 |
| Yamaha | YZF R1 | 2004 | 2014 | RALB140 | 254,00 | RALB140R | 360,00 |
| Yamaha | YZF R1/R1M | 2015 | > | RALB101 | 254,00 | RALB100R | 360,00 |
| Yamaha | YZF R7 | 2021 | > | RALB220 | 264,00 | RALB220R | 384,00 |
| Brembo | 16x18 | - | - | RALB070 | 215,00 | RALB070R | 346,00 |
| Brembo | 19x18 | - | - | RALB070 | 215,00 | RALB070R | 346,00 |
| Brembo | 19x20 | - | - | RALB080 | 215,00 | RALB080R | 346,00 |
| Brembo | MCS | - | - | RALB210 | 215,00 | RALB210R | 346,00 |

RACING REMOTE ADJUSTER - REGISTRO REMOTO RACING

| MODEL - MODELLO | CODE - CODICE | € |
|----------------------------------------------|---------------|--------|
| Bonamici Racing | RRP_BR | 167,00 |
| Brembo original pump - Brembo pompa di serie | RRP_37 | 167,00 |
| Brembo 16x18/19x18/19x20 | RRP_37/R | 167,00 |
| Brembo RCS/RCS Corsa Corta | RRP_43 | 167,00 |

BRAKE LEVER ATTACHMENT - ATTACCO LEVA FRENO

Cod. 0037/R

Cod. 0043

Cod. 0037

Cod. 0038
Cod. 0041
Cod. 0042



REMOTE ADJUSTER - REGISTRO REMOTO

| MODEL - MODELLO | CODE - CODICE | € |
|----------------------------------------------|---------------|-------|
| Bonamici Racing | 00BR | 99,00 |
| Braking | 0042 | 99,00 |
| Brembo original pump - Brembo pompa di serie | 0037 | 99,00 |
| Brembo 16x18/19x18/19x20 | 0037/R | 99,00 |
| Brembo RCS/RCS Corsa Corta | 0043 | 99,00 |
| Discacciati | 0038 | 99,00 |
| PT | 0041 | 99,00 |



REMOTE ADJUSTER
REGISTRO REMOTO

RACING REMOTE ADJUSTER
REGISTRO REMOTO RACING

SPARE PARTS REMOTE ADJUSTER - RICAMBI REGISTRO REMOTO

| DESCRIPTION - DESCRIZIONE | CODE - CODICE | € |
|------------------------------------------------------------------------------------------------------------------|---------------|-------|
| Knob for remote adjuster - Pomello per registro remoto | REGPO | 25,00 |
| Knob for remote adjuster Racing - Pomello per registro remoto Racing | REGPOR | 33,00 |
| Joint for remote adjuster - Snodo per registro remoto | REGSN | 21,00 |
| Joint for remote adjuster Racing - Snodo per registro remoto Racing | REGSNR | 55,00 |
| Bracelet for remote adjuster - Collare per registro remoto | REGCO | 33,00 |
| Bracelet for remote adjuster Racing - Collare per registro remoto Racing | REGCOR | 51,00 |
| Short cable (52,5cm) for remote adjuster - Cavo corto (52,5cm) per registro remoto | REGCC | 11,00 |
| Long cable (77,5cm) for remote adjuster - Cavo lungo (77,5cm) per registro remoto | REGCL | 11,00 |
| Adjuster connection for Bonamici levers - Attacco registro remoto per leve Bonamici | 00BRA | 16,00 |
| Adjuster connection for Brembo OEM - Attacco registro remoto per Brembo di serie | 0037A | 31,00 |
| Adjuster connection for Brembo 16x18 - 19x18 - 19x20 Attacco registro remoto per Brembo 16x18 - 19x18 - 19x20 | 0037RA | 16,00 |
| Adjuster connection for Brembo RCS - Attacco registro remoto per Brembo RCS | 0043RA | 25,00 |
| Adjuster connection for Discacciati / PT / Braking Attacco registro remoto per Discacciati / PT / Braking | 0038A | 16,00 |

PRICES WITHOUT VAT - PREZZI IVA ESCLUSA

LEVERS ACCESSORIES AND SPARE PARTS - ACCESSORI E RICAMBI LEVE

The full range of Bonamici Racing levers is supplied with the half-lever in "standard" version code LL05 in black color. During the purchase it is possible to request the half-lever in "straight" version code LL03 or "racing" version code LL04, different colors and laser engraving are also available, The Bronze color is only available for LL05 levers

L'intera gamma leve Bonamici Racing è fornita con la parte finale della leva nella versione "Standard" codice LL05 di colore nero. Al momento dell'acquisto è possibile richiedere la leva nella versione "Dritta" codice LL03 o "Racing" codice LL04, diversi colori e incisione laser, Il colore Bronzo è disponibile solo per le leve LL05

| DESCRIPTION - DESCRIZIONE | COLOUR- COLORE | CODE - CODICE | € |
|-----------------------------------------------------------------------------------|----------------------------------------------------------------|---------------|-------|
| Colour kit for Bonamici Racing half levers Kit colore per leve Bonamici Racing | black - blue - green - gold orange - red - silver bronze | KLC | - |
| Laser engraving (kit) - Incisione laser (kit) | - | KLS | 15,00 |
| Aluminium half lever "Standard" (RH/LH) Leva in alluminio "Standard" (DX/SX) | black - blue - green - gold orange - red - silver bronze | LL05 | 60,00 |
| Aluminium half lever "Straight" (RH/LH) Leva in alluminio "Dritta" (DX/SX) | black - blue - green - gold orange - red - silver | LL03 | 60,00 |
| Aluminium half lever "Racing" (RH/LH) Leva in alluminio "Racing" (DX/SX) | black - blue - green - gold orange - red - silver | LL04 | 80,00 |

WARNING
ATTENZIONE

The bronze color is only available for the "Standard" lever code LL05
Il colore bronzo è disponibile solo per leve "Standard" codice LL05



Colour for half lever - Colore parte finale leve



Aluminium half lever "Standard" (RH/LH) - Leva in alluminio "Standard" (DX/SX) - cod. LL05



Aluminium half lever "Straight" (RH/LH) - Leva in alluminio "Dritta" (DX/SX) - cod. LL03



Aluminium half lever "Racing" (RH/LH) Leva in alluminio "Racing" (DX/SX) - cod. LL04



LEVER PROTECTIONS - PROTEZIONE LEVE

CARBON LEVER PROTECTION

Made of fine carbon fiber, 100% made in Italy, extremely detailed both internal and external surfaces, it guarantees maximum strength and low weight. This new particular design has been studied in detail through aerodynamics and fluid dynamics studies to reduce the air pressure both on the lever guard itself and on the brake command at high speeds. .

The new design of the lever guard has been created to favor a wide movement of the hand and wrist in the various riding phases and also to facilitate the rapid release of the hand in the event of a fall or accident.

In addition to being a fundamental element for safety, the Bonamici Racing carbon shift guard is a real design object that gives the bike a very beautiful and sporty look.

The peculiarity of the new carbon lever guard is that it is supplied with a titanium screw and it is possible to adjust its position both in the longitudinal axis and in the transversal axis thanks to a new bushing system mounted between the handlebar and the lever guard itself. One of a kind.

The new carbon lever guard is equipped with an ADL16_C adapter, perfect for Bonamici Racing handlebars. For other uses, we recommend consulting the adapter list and requesting the most suitable one for your motorcycle model.

PROTEZIONE LEVA IN CARBONIO

Realizzata in pregiata fibra di carbonio, 100% made in Italy, estremamente dettagliata in entrambe le superfici interna ed esterna, garantisce massima robustezza e peso contenuto. Questo nuovo particolare design è stato studiato nei minimi dettagli attraverso studi di aerodinamica e fluidodinamica per ridurre la pressione dell'aria sia sul paraleva stesso che sul comando del freno alle alte velocità. .

Il nuovo design del paraleva è stato realizzato per favorire un ampio movimento della mano e del polso nelle varie fasi di guida e anche per facilitare il rapido rilascio della mano in caso di caduta o incidente.

Oltre ad essere un elemento fondamentale per la sicurezza, il paraleva in carbonio Bonamici Racing è un vero e proprio oggetto di design che dona alla moto un aspetto molto bello e sportivo.

La particolarità del nuovo paraleva in carbonio è che viene fornito con vite in titanio ed è possibile aggiustarne la posizione sia in asse longitudinale sia in asse trasversale grazie ad un nuovo sistema a boccola montato tra il manubrio ed il paraleva stesso. Unico nel suo genere. Il nuovo paraleva in carbonio è dotato di adattatore ADL16_C, perfetto per semimanubri Bonamici Racing, per altri usi consigliamo di consultare l'elenco adattatori e richiedere quello più adatto al vostro modello di moto.



Code: LPLITE_R

CARBON LEVER PROTECTIONS - PROTEZIONE LEVE IN CARBONIO

DESCRIPTION - DESCRIZIONE

CODE - CODICE

€

| | | |
|-------------------------------------|----------|--------|
| NEW Brake side*- Lato freno* | LPLITE_R | 270,00 |
|-------------------------------------|----------|--------|

ADAPTORS - ADATTATORI

DESCRIPTION - DESCRIZIONE

CODE - CODICE

€

| | | |
|-------------------------------------------------------------------|----------|-------|
| for Bonamici Racing bars tube - per tubi manubrio Bonamici Racing | ADLT_C | 30,00 |
| from ø13mm to ø 14mm tube - per tubo da ø13mm a ø14mm | ADL13_C | 34,00 |
| from ø14mm to ø 15mm tube - per tubo da ø14mm a ø15mm | ADL14_C | 34,00 |
| from ø15mm to ø 16mm tube - per tubo da ø15mm a ø16mm | ADL15_C | 34,00 |
| from ø16mm to ø 17mm tube - per tubo da ø16mm a ø17mm | ADL16_C | 34,00 |
| from ø17mm to ø 18mm tube - per tubo da ø17mm a ø18mm | ADL17_C | 34,00 |
| from ø18mm to ø 19mm tube - per tubo da ø18mm a ø19mm | ADL18_C | 34,00 |
| from ø19mm to ø 20mm tube - per tubo da ø19mm a ø20mm | ADL19_C | 34,00 |
| from ø20mm to ø 21mm tube - per tubo da ø20mm a ø21mm | ADL20_C | 34,00 |
| Aprilia RS 660 | ADL660_C | 24,00 |
| BMW S 1000 RR (2008-2018) | ADLB_C | 34,00 |
| BMW S 1000 RR (2019->) | ADLRR_C | 24,00 |
| Ducati Panigale V4 | ADL16_C | 34,00 |
| Honda CBR1000RR-R Fireblade (2020/>) | ADLH19_C | 34,00 |
| Honda CBR 1000 RR (2008/2016) | ADL19_C | 34,00 |
| Honda CBR 600 RR | ADL19_C | 34,00 |
| Kawasaki ZX-10R (2011/>) | ADLZX_C | 30,00 |
| Kawasaki Ninja 400 | ADLRR_C | 24,00 |
| MV Agusta F3 675/800 | ADL18_C | 34,00 |
| MV Agusta F4 | ADL16_C | 34,00 |
| MV Agusta Brutale 675/800 | ADL14_C | 34,00 |
| Suzuki GSX-R 1000 (2017/>) | ADLRR_C | 24,00 |
| Triumph Speed Triple 1200 RS | ADL660_C | 24,00 |
| Triumph Speed Triple 1200 RR | ADLST_C | 30,00 |
| Yamaha YZF R1 (1998/>) | ADLY_C | 30,00 |
| Yamaha YZF R3 (2015/>) | ADLY_C | 30,00 |
| Yamaha YZF R6 (2006/>) | ADLY_C | 30,00 |
| Yamaha YZF R7 (2021/>) | ADLY_C | 30,00 |

WARNING ATTENZIONE

(*) the lever protection includes the ADL16_C adaptor, for other application please choose the correct adaptor.

(*) il paraleva viene fornito con l'adattatore ADL16_C, per altri impieghi consultare la lista degli adattatori.



LEVER PROTECTIONS - PROTEZIONE LEVE



FRONTEPEG SILVER
PUNTALINO ARGENTO



FRONTEPEG BRONZE
PUNTALINO BRONZO



FRONTEPEG GOLD
PUNTALINO ORO



FRONTEPEG ORANGE
PUNTALINO ARANCIO



FRONTEPEG RED
PUNTALINO ROSSO



FRONTEPEG GREEN
PUNTALINO VERDE



FRONTEPEG BLUE
PUNTALINO BLU

WARNING ATTENZIONE

(*) the lever protection includes the ADL16 adaptor, for other application please choose the correct adaptor.

(*) il paraleva viene fornito con l'adattatore ADL16, per altri impieghi consultare la lista degli adattatori.

ALUMINUM LEVER PROTECTIONS - PROTEZIONE LEVE IN ALLUMINIO

| DESCRIPTION - DESCRIZIONE | COLOUR - COLORE | CODE - CODICE | € |
|---------------------------------------------------------------------------|-------------------------------------------------------------|---------------|--------|
| Brake side*- Lato freno* | black - blue - bronze - green gold orange - red - silver | LPRR | 142,00 |
| Brake side (short version)* Lato freno (tipo corto)* | black - blue - bronze - green gold orange - red - silver | LPRC | 142,00 |
| Clutch side*- Lato frizione* | black - blue - bronze - green gold orange - red - silver | LPRL | 142,00 |
| Frontpeg spare part(brake side) Puntalino di ricambio (lato freno) | black - blue - bronze - green gold orange - red - silver | LPP_DX | 45,00 |
| Frontpeg spare part(clutch side) Puntalino di ricambio (lato frizione) | black - blue - bronze - green gold orange - red - silver | LPP_SX | 45,00 |
| Laser engraving - Incisione laser | - | LLS | 15,00 |
| BMW S 1000 R (2021 />) Brake side - Lato freno | black - blue - bronze - green gold orange - red - silver | LPRR10 | 142,00 |
| BMW S 1000 R (2021 />) Clutch side - Lato frizione | black - blue - bronze - green gold orange - red - silver | LPRL10 | 142,00 |

ADAPTORS - ADATTATORI

| DESCRIPTION - DESCRIZIONE | CODE - CODICE | € |
|-------------------------------------------------------------------|---------------|-------|
| for Bonamici Racing bars tube - per tubi manubrio Bonamici Racing | ADLT | 26,00 |
| for SM55S1K handlebars - per semimanubri SM55S1K | ADLS1K | 52,00 |
| from ø13mm to ø14mm tube - per tubo da ø13mm a ø14mm | ADL13 | 30,00 |
| from ø14mm to ø15mm tube - per tubo da ø14mm a ø15mm | ADL14 | 30,00 |
| from ø15mm to ø16mm tube - per tubo da ø15mm a ø16mm | ADL15 | 30,00 |
| from ø16mm to ø17mm tube - per tubo da ø16mm a ø17mm | ADL16 | 30,00 |
| from ø17mm to ø18mm tube - per tubo da ø17mm a ø18mm | ADL17 | 30,00 |
| from ø18mm to ø19mm tube - per tubo da ø18mm a ø19mm | ADL18 | 30,00 |
| from ø19mm to ø20mm tube - per tubo da ø19mm a ø20mm | ADL19 | 30,00 |
| from ø20mm to ø21mm tube - per tubo da ø20mm a ø21mm | ADL20 | 30,00 |
| Aprilia RS 660 | ADL660 | 20,00 |
| BMW S 1000 RR (2008-2018) | ADLB | 30,00 |
| BMW S 1000 RR (2019->) | ADLRR | 20,00 |
| Ducati Panigale V4 | ADL16 | 30,00 |
| Honda CBR1000RR-R Fireblade (2020->) | ADLH19 | 30,00 |
| Honda CBR 1000 RR (2008/2016) | ADL19 | 30,00 |
| Honda CBR 600 RR | ADL19 | 30,00 |
| Kawasaki ZX-10R (2011->) | ADLZX | 26,00 |
| Kawasaki Ninja 400 | ADLRR | 20,00 |
| MV Agusta F3 675/800 | ADL18 | 30,00 |
| MV Agusta F4 | ADL16 | 30,00 |
| MV Agusta Brutale 675/800 | ADL14 | 30,00 |
| Suzuki GSX-R 1000 (2017->) | ADLRR | 20,00 |
| Triumph Speed Triple 1200 RS | ADL660 | 20,00 |
| Triumph Speed Triple 1200 RR | ADLST | 26,00 |
| Yamaha YZF R1 (1998->) | ADLY | 26,00 |
| Yamaha YZF R3 (2015->) | ADLY | 26,00 |
| Yamaha YZF R6 (2006->) | ADLY | 26,00 |
| Yamaha YZF R7 (2021->) | ADLY | 26,00 |



HANDLEBARS - SEMIMANUBRI

Tube for unlifted handlebars

Tubo per semimanubrio non rialzato

| | |
|--------------------------------------------------|--------|
| Tube length - Lunghezza tubo | 245 mm |
| Tube useful length - Lunghezza utilizzabile tubo | 225 mm |
| Outer tube diameter - Diametro esterno tubo | 22 mm |
| Inner tube diameter - Diametro interno tubo | 16 mm |

Tube for lifted handlebars

Tubo per semimanubrio rialzato

| | |
|--------------------------------------------------|--------|
| Tube length - Lunghezza tubo | 270 mm |
| Tube useful length - Lunghezza utilizzabile tubo | 235 mm |
| Outer tube diameter - Diametro esterno tubo | 22 mm |
| Inner tube diameter - Diametro interno tubo | 16 mm |

UNLIFTED HANDLEBARS
SEMIMANUBRI NON RIALZATI



LIFTED HANDLEBARS
SEMIMANUBRI RIALZATI



WARNING - ATTENZIONE

At the time of purchase it is necessary to choose the ideal diameter, first make sure of the diameter of the front forks of the bike and then choose the right diameter of the handlebars.

Al momento dell'acquisto occorre scegliere il diametro ideale, per prima cosa assicurarsi del diametro forcelle anteriori della moto e successivamente scegliere il giusto diametro dei semimanubri.

Bonamici Racing realizes for the major sports bikes, handlebars that allow a sporty driving at the highest levels and a perfect feeling in all conditions. Two version: raised 15 mm and not raised, both with inclination of 6.5° degrees. Each element of the Bonamici Racing handlebars is made from solid billet aluminium machined with cnc technology.

La Bonamici Racing realizza per le maggiori moto sportive, i semimanubri non rialzati e rialzati di 15 mm ed inclinati di 6,5° che permettono una guida sportiva ai massimi livelli ed un feeling perfetto in ogni condizione. Ogni elemento dei semimanubri Bonamici Racing è realizzato in alluminio ricavato dal pieno.



HANDLEBARS - SEMIMANUBRI

DESCRIPTION - DESCRIZIONE

| DESCRIPTION - DESCRIZIONE | CODE - CODICE | € |
|-------------------------------------------------------------------------------------------------------------------------------|---------------|--------|
| Diameter 37 mm lifted - Diametro 37 mm rialzati | SM37 | 231,00 |
| Diameter 41 mm lifted - Diametro 41 mm rialzati | SM41 | 231,00 |
| Diameter 41 mm_30mm lifted - Diametro 41 mm_rialzati 30mm | SM41_30 | 243,00 |
| Diameter 47 mm lifted - Diametro 47 mm rialzati | SM47 | 243,00 |
| Diameter 48 mm lifted - Diametro 48 mm rialzati | SM48 | 243,00 |
| Diameter 50 mm lifted - Diametro 50 mm rialzati | SM50 | 243,00 |
| Diameter 50 mm unlifted - Diametro 50 mm non rialzati | SM50B | 243,00 |
| Diameter 51 mm lifted - Diametro 51 mm rialzati | SM51 | 243,00 |
| Diameter 51 mm lifted - Diametro 51 mm rialzati (Aprilia RS 660) ⁴ (Aprilia RSV4 2021) Spare tube - code RASM_2 | SM51A | 243,00 |
| Diameter 51 mm unlifted - Diametro 51 mm non rialzati | SM51B | 243,00 |
| Diameter 52 mm lifted - Diametro 52 mm rialzati | SM52 | 243,00 |
| Diameter 52 mm unlifted - Diametro 52 mm non rialzati | SM52B | 243,00 |
| Diameter 53 mm lifted - Diametro 53 mm rialzati | SM53 | 243,00 |
| Diameter 53 mm unlifted - Diametro 53 mm non rialzati | SM53B | 243,00 |
| Diameter 53 mm unlifted - Diametro 53 mm (Ducati 1199S Panigale) ¹ | SM53PA | 298,00 |
| Diameter 53 mm unlifted - Diametro 53 mm (Panigale V2) ¹ | SM53PV2 | 298,00 |
| Diameter 53 mm unlifted - Diametro 53 mm (Ducati Panigale V4/V4S) ¹ | SM53PV4 | 312,00 |
| Diameter 53 mm unlifted - Diametro 53 mm (Ducati Panigale V4R) ¹ | SM53PV4R | 312,00 |
| Diameter 55 mm lifted - Diametro 55 mm rialzati | SM55 | 243,00 |
| Diameter 55 mm unlifted - Diametro 55 mm non rialzati | SM55B | 243,00 |
| Diameter 55 mm lifted - Diametro 55 mm rialzati (BMW S 1000 RR / M 1000 RR '19/>) ² Spare tube - code RASM_2 | SM55S1K | 355,00 |
| Diameter 55 mm lifted - Diametro 55 mm rialzati (BMW S 1000 RR / M 1000 RR '19/>) ³ Spare tube - code RASM_2 | SM55S1KW | 243,00 |
| Diameter 55 mm unlifted - Diametro 55 mm non rialzati (BMW S 1000 RR / M 1000 RR '19/>) ² Spare tube - code RASM_2 | SM55BS1K | 355,00 |
| Diameter 57 mm lifted - Diametro 57 mm rialzati | SM57 | 255,00 |
| Steering stops - Coppia battute di sterzo | BS02 | 63,00 |



Diameter 53 mm unlifted
Diametro 53 mm (Ducati Panigale V4/V4S)- cod. SM53PV4



Diameter 55 mm lifted
Diametro 55 mm (BMW S 1000 RR '19/>)- cod. SM55S1K

HANDLEBARS SPARE PARTS - RICAMBI SEMIMANUBRI

DESCRIPTION - DESCRIZIONE

| DESCRIPTION - DESCRIZIONE | CODE - CODICE | € |
|----------------------------------------------------------------------------------------------------------------------------------------------------------------------------------------------|---------------|--------|
| Clamps for OEM steering plate (BMW S 1000 RR - M 1000 RR '19 / >) Coppia di supporti ad arco per piastra di sterzo originale (BMW S 1000 RR - M 1000 RR '19 / >) | BMRS1K | 113,00 |
| Pair of balancers for SM55S1K/SM55B - Coppia contrappesi per SM55S1K/SM55B | ADLS1K_2 | 95,00 |
| Spare bracket right side - Bracciale di ricambio lato DX | BMRD | 94,00 |
| Spare bracket left side - Bracciale di ricambio lato SX | BMRS | 94,00 |
| Spare tube for lifted handlebars (Tube length 270 mm - Tube useful length 235 mm) Tubo di ricambio per semimanubri rialzati (Lunghezza tubo 270 mm - Lunghezza utilizzabile 235mm) | RASM_1 | 44,00 |
| Spare tube for unlifted handlebars (Tube length 245 mm - Tube useful length 225 mm) Tubo ricambio per semimanubri non rialzati (Lunghezza tubo 245 mm - Lunghezza utilizzabile 225mm) | RASM_2 | 44,00 |
| Tube cap - Tappo tubo | TASM | 9,00 |
| Bracket for steering dumper - Bracciale ammortizzatore di sterzo | BAMS | 63,00 |

WARNING - ATTENZIONE

- 1 • Include the bracket for steering dumper
• Include il bracciale per l'ammortizzatore di sterzo
- 2 • Handlebars to use the OEM triple clamp (include the clamps for steering plate) - Spare tube code RASM_2
• Semimanubri utilizzabili con la piastra di sterzo originale (Include la coppia di supporti ad arco per la piastra di sterzo)
Tubo di ricambio cod. RASM_2
- 3 • Handlebars to use with Bonamici Racing top triple clamp (not include the clamps for steering plate) - Spare tube code RASM_2
• Semimanubri utilizzabili con la piastra di sterzo Bonamici Racing (non include la coppia di supporti ad arco per la piastra di sterzo)
Tubo di ricambio cod. RASM_2
- 4 • We recommend purchasing the steering stops code - BS02
• Consigliamo l'acquisto delle battute di sterzo codice - BS02



CHAIN ADJUSTER - TENDICATENA



Made of Ergal machined from solid with CNC technology, the Bonamici Racing chain adjuster is robust and effective, with the use of bearings to completely eliminate friction and for the first time with adjustable micrometric system. It is possible to customize the inner part in various colors, while the outer part is only available in black color

Realizzato in Ergal ricavato dal pieno con tecnologia CNC, il tendicatena Bonamici Racing è robusto ed efficace, con l'uso di cuscinetti per eliminare completamente l'attrito e le posizioni regolabili micrometricamente. È possibile la personalizzazione in vari colori per la parte interna, mentre la parte esterna è disponibile solo di colore nero



Gold



Red



Blue



Black



Silver



PRICES WITHOUT VAT - PREZZI IVA ESCLUSA

| BRAND | MODEL - MODELLO | FROM - DAL | TO - AL | CODE - CODICE | € |
|----------|--------------------------------|------------|---------|---------------|--------|
| Aprilia | RS 660 - TUONO 660 | 2020 | > | CHAD12 | 249,00 |
| Aprilia | RSV4 / RSV4 Factory / TUONO V4 | 2021 | > | CHAD13 | 249,00 |
| Aprilia | RSV4 / Tuono V4 | 2015 | 2020 | CHAD04 | 249,00 |
| BMW | S 1000 RR | 2008 | 2018 | CHAD01 | 249,00 |
| BMW | S 1000 RR | 2019 | > | CHAD09 | 249,00 |
| BMW | S 1000 R | 2012 | 2020 | CHAD01 | 249,00 |
| BMW | S 1000 R | 2021 | > | CHAD09 | 249,00 |
| Honda | CBR 1000 RR | 2008 | 2016 | CHAD08 | 249,00 |
| Honda | CBR 1000 RR Fireblade | 2017 | 2019 | CHAD05 | 249,00 |
| Honda | CBR1000RR-R Fireblade | 2020 | > | CHAD10 | 249,00 |
| Kawasaki | ZX-10R | 2016 | > | CHAD02 | 249,00 |
| Suzuki | GSX-R 1000 | 2017 | > | CHAD06 | 249,00 |
| Suzuki | GSX-S 1000 | 2021 | > | CHAD06 | 249,00 |
| Yamaha | YZF R6 | 2017 | > | CHAD07 | 249,00 |
| Yamaha | YZF R1/MT-10 | 2015 | 2019 | CHAD03 | 249,00 |
| Yamaha | YZF R1 | 2020 | > | CHAD11 | 249,00 |





OIL TANK - SEBATOIO OLIO



| DESCRIPTION - DESCRIZIONE | COLOUR- COLORE | CODE - CODICE | € |
|------------------------------------------------------|---------------------------------------------------------------|---------------|-------|
| 8 ml Rear oil tank Serbatoio olio posteriore 8 ml | black - blue - bronze - green gold - orange - red - silver | 0040 | 60,00 |
| Bracket tank - Supporto serbatoio | black | 00S4 | 30,00 |

PRICES WITHOUT VAT - PREZZI IVA ESCLUSA



The new range of reservoirs is another novelties of Bonamici Racing. The 8ml version has been redesigned with a more modern design. All reservoirs are made with aluminum machined from solid and are available in various colors.

La nuova gamma di vasche olio è una delle novità della Bonamici Racing. La versione da 8ml è stata riprogettata con un design più moderno. I serbatoi sono in alluminio ricavati dal pieno e sono disponibili in vari colori.

SWING ARMS SPOOLS - SUPPORTI CAVALLETTO



| DESCRIPTION - DESCRIZIONE | COLOUR- COLORE | CODE - CODICE | € |
|---------------------------|---------------------------------------------------------------|---------------|-------|
| standard 6 mm | black - blue - bronze - green gold - orange - red - silver | 0025 | 29,00 |
| standard 8 mm | black - blue - bronze - green gold - orange - red - silver | 0026 | 29,00 |
| Kawasaki 10 x 1,25 | black - blue - bronze - green gold - orange - red - silver | 0030 | 33,00 |
| KTM 790/890 Duke 10 x 1,5 | black - blue - bronze - green gold - orange - red - silver | 0031 | 33,00 |
| racing 6 mm | black | 0027 | 33,00 |
| racing 8 mm | black | 0028 | 33,00 |

PRICES WITHOUT VAT - PREZZI IVA ESCLUSA



The rear stand supports, made in aluminum machined from solid, are available in the following sizes, 6mm, 8mm and 10x1.25, are available in various colors and the Racing version has a larger point of foothold.

I supporti posteriori per i cavalletti in alluminio ricavati dal pieno sono disponibili nelle misure da 6mm, da 8mm e da 10x1,25 in vari colori ed inoltre nella versione racing con una sede per l'attacco più ampia.



BLOCKS MIRROR - TAPPI SPECCHIO



Silver



Gold



Orange



Red



Blue



Black

| BRAND | MODEL - MODELLO | COLOUR - COLORE | CODE - CODICE | € |
|--------|--------------------------------------|----------------------------------------------|---------------|-------|
| BMW | S 1000 RR - M 1000 RR (2019/ >) | black - blue - gold orange - red - silver | BM07 | 63,00 |
| Ducati | 899/1199 Panigale | black - blue - gold orange - red - silver | BM01 | 63,00 |
| Ducati | 959/1299 Panigale | black - blue - gold orange - red - silver | BM03 | 63,00 |
| Ducati | Panigale V2/V4/V4S | black - blue - gold orange - red - silver | BM06 | 63,00 |
| Honda | CBR 1000 RR Fireblade/RR-R (2017/ >) | black - blue - gold orange - red - silver | BM05 | 63,00 |
| Suzuki | GSX-R 1000 (2017/ >) | black - blue - gold orange - red - silver | BM04 | 63,00 |
| Yamaha | YZF R3 (2015-2018) | black - blue - gold orange - red - silver | BM02 | 63,00 |
| Yamaha | YZF R7 (2021/ >) | black - blue - gold orange - red - silver | BM08 | 63,00 |



BRAND **MODEL - MODELLO** **THREAD - FILETTO** **COLOUR - COLORE** **CODE - CODICE** **€**

| | | | | | |
|----------|----------------------------------------------|-------------|------------------------------------------------------|------|-------|
| Aprilia | Tuareg 660 | M18x1,5 | black - blue - green gold - orange - red - silver | T010 | 35,00 |
| Aprilia | RS 660 | M20x1,5 | black - blue - green gold - orange - red - silver | T011 | 35,00 |
| BMW | - | M24 x 2 | black - blue - green gold - orange - red - silver | T004 | 35,00 |
| Ducati | universal* | M22 x 1,5 | black - blue - green gold - orange - red - silver | T001 | 35,00 |
| Ducati | Hypermotard 821 | M20x2,5 | black - blue - green gold - orange - red - silver | T008 | 35,00 |
| Ducati | Monster 821/1100/1200 | M20x2,5 | black - blue - green gold - orange - red - silver | T008 | 35,00 |
| Ducati | Streetfighter 848 | M20x2,5 | black - blue - green gold - orange - red - silver | T008 | 35,00 |
| Ducati | 848/1098/1198 | M19,5 x 2,5 | black - blue - green gold - orange - red - silver | T003 | 35,00 |
| Ducati | 899/1199 Panigale | M19,5 x 2,5 | black - blue - green gold - orange - red - silver | T003 | 35,00 |
| Ducati | 1299 Panigale/V2 | M20x2,5 | black - blue - green gold - orange - red - silver | T008 | 35,00 |
| Honda | universal* | M19,5 x 2,5 | black - blue - green gold - orange - red - silver | T003 | 35,00 |
| Kawasaki | universal* | M30 x 1,5 | black - blue - green gold - orange - red - silver | T002 | 35,00 |
| Kawasaki | Ninja 250/400 | M20x2,5 | black - blue - green gold - orange - red - silver | T008 | 35,00 |
| Kawasaki | Z650 | M20x2,5 | black - blue - green gold - orange - red - silver | T008 | 35,00 |
| Kawasaki | Z800/900 | M20x2,5 | black - blue - green gold - orange - red - silver | T008 | 35,00 |
| Kawasaki | Z1000 14/15 | M20x2,5 | black - blue - green gold - orange - red - silver | T008 | 35,00 |
| Suzuki | universal* | M20 x 1,5 | black - blue - green gold - orange - red - silver | T005 | 35,00 |
| Triumph | universal* | M19,5x2,5 | black - blue - green gold - orange - red - silver | T003 | 35,00 |
| Triumph | Street Triple 765 Speed Triple 1200 RS/RR | M20x2,5 | black - blue - green gold - orange - red - silver | T009 | 35,00 |
| Yamaha | universal* | M27 x 3 | black - blue - green gold - orange - red - silver | T007 | 35,00 |
| Yamaha | MT-03 | M19,5x2,5 | black - blue - green gold - orange - red - silver | T003 | 35,00 |
| Yamaha | MT-09 | M20x2,5 | black - blue - green gold - orange - red - silver | T008 | 35,00 |

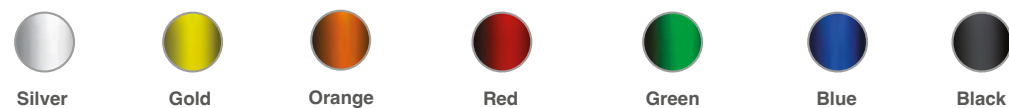

PRICES WITHOUT VAT - PREZZI IVA ESCLUSA

TANK CAPS - TAPPI SERBATOIO



Silver



Gold



Orange



Red



Blue



| BRAND | MODEL - MODELLO | FROM - DAL | TO - AL | CODE - CODICE | € |
|-----------|------------------------------------------|------------|---------|---------------|--------|
| APRILIA | RS 660 / TUONO 660 | 2020 | > | FC090 | 107,00 |
| APRILIA | RSV 1000 / RSV4 / TUONO / RSV4 Factory | 2004 | > | FC030 | 107,00 |
| BMW | S 1000 R - S 1000 RR - M 1000RR - HP4 | 2008 | > | FC040 | 107,00 |
| DUCATI | 748 / 916 / 996 / 998 / 848 / 1098 | - | - | FC010 | 107,00 |
| DUCATI | Panigale 899 / 1199 / 1299 / V2/ V4/ V4R | 2012 | > | FC050 | 107,00 |
| DUCATI | Streetfighter / Scrambler 800 | 2009 | > | FC050 | 107,00 |
| HONDA | CB 500 F - CBR 500 R - CBR 650 R/F | 2012 | > | FC120 | 107,00 |
| HONDA | CBR 600 RR | 2003 | > | FC160 | 107,00 |
| HONDA | CBR 1000 RR | 2004 | 2013 | FC160 | 107,00 |
| HONDA | CBR 1000 RR | 2014 | 2016 | FC150 | 107,00 |
| HONDA | CBR 1000 RR Fireblade/RR-R | 2017 | > | FC120 | 107,00 |
| KAWASAKI | Ninja 250/400 | 2018 | > | FC170 | 107,00 |
| KAWASAKI | ZX-6R | 2007 | 2017 | FC070 | 107,00 |
| KAWASAKI | ZX-6R | 2019 | > | FC170 | 107,00 |
| KAWASAKI | ZX-10R | 2006 | 2020 | FC070 | 107,00 |
| KAWASAKI | ZX-10R | 2021 | > | FC170 | 107,00 |
| KAWASAKI | ER-6N/Z 800/Z 1000 | 2007 | 2016 | FC070 | 107,00 |
| KAWASAKI | Z650/Z900 | 2017 | 2018 | FC170 | 107,00 |
| KTM | RC 390/Duke 390/Duke 790/890 | 2017 | > | FC200 | 107,00 |
| KTM | 1290 Superduke | 2014 | > | FC210 | 107,00 |
| MV AGUSTA | F3 675/800 - Brutale 675/800 | 2011 | 2018 | FC090 | 107,00 |
| MV AGUSTA | F4 - Brutale | 2010 | 2018 | FC190 | 107,00 |
| SUZUKI | GSX-R 600/750 | 2004 | 2018 | FC080 | 107,00 |
| SUZUKI | GSX-R 1000 | 2003 | > | FC080 | 107,00 |
| SUZUKI | GSX-S 750 | 2015 | > | FC080 | 107,00 |
| SUZUKI | GSX-S 1000 | 2021 | > | FC080 | 107,00 |
| TRIUMPH | Street Triple (all M.Y.) | - | - | FC220 | 107,00 |
| TRIUMPH | Daytona (all M.Y.) | - | - | FC220 | 107,00 |
| TRIUMPH | Speed Triple (all M.Y.) | - | - | FC220 | 107,00 |
| YAMAHA | YZF R3 | 2015 | > | FC110 | 107,00 |
| YAMAHA | YZF R6 | 1999 | > | FC110 | 107,00 |
| YAMAHA | YZF R1/R1M | 1998 | > | FC110 | 107,00 |
| YAMAHA | MT-03/MT-07/MT-09 | - | - | FC110 | 107,00 |
| YAMAHA | YZF R7 | 2021 | > | FC110 | 107,00 |

SPARE PART AND ACCESSORIES - ACCESSORI E RICAMBI

| DESCRIPTION - DESCRIZIONE | CODE - CODICE | € |
|-----------------------------------------------------------|---------------|-------|
| Center cap - Tappo centrale | FC00C | 61,00 |
| Extra colour (frame only) Colore extra (parte esterna) | FC00K | 25,00 |

DESCRIPTION - DESCRIZIONE

CODE - CODICE €

| | | |
|--------------------------------------------------------------------------------------------|-------|-------|
| Chain protection with carbon plate Paracatena inferiore con pinna in carbonio | ICP1 | 95,00 |
| Chain protection with aluminum plate Paracatena inferiore con pinna in alluminio | ICP2 | 63,00 |
| Carbon plate spare part - Pinna in carbonio di ricambio | ICPRC | 40,00 |
| Aluminum plate spare part - Pinna in alluminio di ricambio | ICPRA | 29,00 |

WARNING ATTENZIONE

This product expect to be drilled and threaded on the swing arms

Questo prodotto richiede la foratura e filettatura del forcellone

CHAIN PROTECTION WITH CARBON PLATE PARACATENA CON PINNA IN CARBONIO



CHAIN PROTECTION WITH ALUMINUM PLATE PARACATENA CON PINNA IN ALLUMINIO





MODELS MODELLI

INDEX MODELS - INDICE MODELLI

| | |
|---------------------------------------------------|-----|
| APRILIA RSV4 (2021 / >) | 88 |
| APRILIA RSV4 (2017/ 2020) | 89 |
| APRILIA RS 660 / TUONO 660 (2020 / >) | 90 |
| BMW S 1000 RR (2017/2018) | 91 |
| BMW S 1000 RR (2019/ >) | 92 |
| BMW M 1000 RR (2021 / >) | 93 |
| BMW S 1000 R (2021/ >) | 94 |
| BMW S 1000 XR (2020/ >) | 95 |
| DUCATI 899/959/1199/1299 PANIGALE | 96 |
| DUCATI PANIGALE V2 | 97 |
| DUCATI PANIGALE V4/V4S/V4R | 98 |
| DUCATI STREETFIGHTER V4/V4S | 99 |
| HONDA CBR 1000 RR FIREBLADE (2017/2019) | 100 |
| HONDA CBR 1000 RR-R FIREBLADE (2020/ >) | 101 |
| HONDA CB 500 F (2019 / >) | 102 |
| KAWASAKI ZX-10R (2016/2020) | 103 |
| NEW KAWASAKI ZX-10R (2021/>) | 104 |
| KAWASAKI NINJA 400 | 105 |
| KAWASAKI Z650 | 106 |
| KAWASAKI Z900 | 107 |
| KTM RC390 (2014/ >) | 108 |
| KTM 790/890 DUKE | 109 |
| KTM 1290 SUPERDUKE R (2020/>) | 110 |
| KTM 1290 SUPERDUKE (2017/2019) | 111 |
| MV AGUSTA F3 | 112 |
| SUZUKI GSX-R 1000 (2017/ >) | 113 |
| SUZUKI GSX-S 1000 (2021/ >) | 114 |
| TRIUMPH STREET TRIPLE (2017/ >) | 115 |
| TRIUMPH SPEED TRIPLE (2011/ 2020) | 116 |
| NEW TRIUMPH SPEED TRIPLE 1200 RS (2021/ >) | 117 |
| NEW TRIUMPH SPEED TRIPLE 1200 RR (2022/ >) | 118 |
| YAMAHA YZF R1 (2015/2019) | 119 |
| YAMAHA YZF R1 (2020/>) | 120 |
| YAMAHA YZF R6 (2017/ >) | 121 |
| YAMAHA YZF R7 (2021/ >) | 122 |
| YAMAHA YZF R3 | 123 |
| YAMAHA MT-10 | 124 |



DESCRIPTION - DESCRIZIONE

CODE - CODICE

€

| DESCRIPTION - DESCRIZIONE | CODE - CODICE | € |
|------------------------------------------------------------------|---------------|--------|
| Rearset (normal shifting) - Pedane (cambio normale) | A005S | 544,00 |
| Rearset (reverse shifting) - Pedane (cambio rovesciato) | A005SR | 544,00 |
| Engine protections - Protezioni motore | CP107 | 359,00 |
| Dashboard protection - Protezione strumentazione | DCP13 | 191,00 |
| Lifted handlebars - Semimanubri rialzati | SM51A | 243,00 |
| Top triple clamp "Street" - Piastra di sterzo superiore "Street" | PSA1 | 406,00 |
| Top triple clamp "Race" - Piastra di sterzo superiore "Race" | PSA1R | 332,00 |
| Brake lever - Leva freno | LB110 | 146,00 |
| Brake lever with remote adjuster - Leva freno con registro a sx | RALB110 | 254,00 |
| Clutch lever - Leva frizione | LC010 | 116,00 |
| Full clutch lever - Leva frizione completa | LCF | 173,00 |
| Adjustable full clutch lever - Leva frizione completa regolabile | LCFR | 231,00 |
| Levers kit - Kit leve | KL010 | 247,00 |
| Lever protection brake side - Protezione leva lato freno | LPRR | 142,00 |
| Carbon lever protection - Protezione leva in carbonio | LPLITE_R | 270,00 |
| Tank cap - Tappo serbatoio | FC030 | 107,00 |
| 8ml Oil tank - Serbatoio olio 8ml | 0040 | 60,00 |
| Chain protection - Pinna paracatena | ICP1 | 95,00 |
| Chain adjuster - Tencicatena | CHAD13 | 249,00 |
| Swing arms spools - Supporti cavalletto | 0025 | 29,00 |
| Swing arms spools "racing" - Supporti cavalletto "racing" | 0027 | 33,00 |



DESCRIPTION - DESCRIZIONE

CODE - CODICE

€

| | | |
|------------------------------------------------------------------|----------|--------|
| Rearset (normal shifting) - Pedane (cambio normale) | A005S | 544,00 |
| Rearset (reverse shifting) - Pedane (cambio rovesciato) | A005SR | 544,00 |
| Engine protections - Protezioni motore | CP003 | 359,00 |
| Dashboard protection - Protezione strumentazione | DCP06 | 191,00 |
| Unlifted handlebars - Semimanubri bassi | SM51B | 243,00 |
| Lifted handlebars - Semimanubri rialzati | SM51 | 243,00 |
| Top triple clamp "Street" - Piastra di sterzo superiore "Street" | PSA1 | 406,00 |
| Top triple clamp "Race" - Piastra di sterzo superiore "Race" | PSA1R | 332,00 |
| Brake lever - Leva freno | LB110 | 146,00 |
| Brake lever with remote adjuster - Leva freno con registro a sx | RALB110 | 254,00 |
| Clutch lever - Leva frizione | LC010 | 116,00 |
| Full clutch lever - Leva frizione completa | LCF | 173,00 |
| Adjustable full clutch lever - Leva frizione completa regolabile | LCFR | 231,00 |
| Levers kit - Kit leve | KL010 | 247,00 |
| Lever protection brake side - Protezione leva lato freno | LPRR | 142,00 |
| Carbon lever protection - Protezione leva in carbonio | LPLITE_R | 270,00 |
| Tank cap - Tappo serbatoio | FC030 | 107,00 |
| 8ml Oil tank - Serbatoio olio 8ml | 0040 | 60,00 |
| Chain protection - Pinna paracatena | ICP1 | 95,00 |
| Chain adjuster - Tindicatena | CHAD04 | 249,00 |
| Swing arms spools - Supporti cavalletto | 0025 | 29,00 |
| Swing arms spools "racing" - Supporti cavalletto "racing" | 0027 | 33,00 |



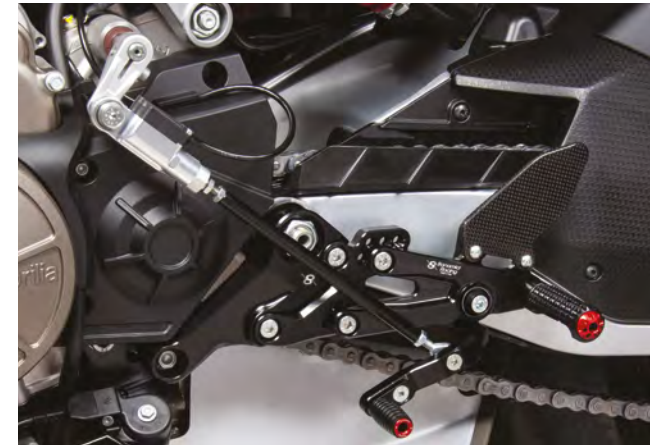

DESCRIPTION - DESCRIZIONE

CODE - CODICE €

| | | |
|--------------------------------------------------|-------|--------|
| Rearset - Pedane | A006 | 708,00 |
| Dashboard protection - Protezione strumentazione | DCP12 | 191,00 |

DESCRIPTION - DESCRIZIONE

CODE - CODICE €

| | | |
|------------------------------------------------------------------------------------|----------|--------|
| Lifted handlebars (only for RS 660) - Semimanubri rialzati (solo per RS 660) | SM51A | 243,00 |
| Steering stops - Coppia battute di sterzo | BS02 | 63,00 |
| Top triple clamp (only for RS 660) - Piastra di sterzo superiore (solo per RS 660) | PSA2 | 478,00 |
| Engine protections - Protezioni motore | CP114 | 458,00 |
| Brake lever - Leva freno | LB110 | 146,00 |
| Brake lever with remote adjuster - Leva freno con registro a sx | RALB110 | 254,00 |
| Clutch lever - Leva frizione | LC010 | 116,00 |
| Full clutch lever - Leva frizione completa | LCF | 173,00 |
| Adjustable full clutch lever - Leva frizione completa regolabile | LCFR | 231,00 |
| Levers kit - Kit leve | KL010 | 247,00 |
| Racing remote adjuster - Registro remoto racing | RRP_BR | 167,00 |
| Remote adjuster - Registro remoto | 00BR | 99,00 |
| Lever protection brake side - Protezione leva lato freno | LPRR | 142,00 |
| Lever protection clutch side - Protezione leva lato frizione | LPRL | 142,00 |
| Carbon lever protection - Protezione leva in carbonio | LPLITE_R | 270,00 |
| Tank cap - Tappo serbatoio | FC090 | 107,00 |
| 8ml Oil tank - Serbatoio olio 8ml | 0040 | 60,00 |
| Chain protection with carbon plate - Paracatena con pinna in carbonio | ICP1 | 95,00 |
| Chain protection with aluminium plate - Paracatena con pinna in alluminio | ICP2 | 63,00 |
| Chain adjuster - Tendicatena | CHAD12 | 249,00 |
| Swing arms spools "racing" - Supporti cavalletto "racing" | 0027 | 33,00 |
| Oil cap - Tappo olio | T011 | 35,00 |



DESCRIPTION - DESCRIZIONE

CODE - CODICE

€

| | | |
|------------------------------------------------------------------|----------|--------|
| Rearset - Pedane | B005 | 476,00 |
| Top triple clamp "Street" - Piastra di sterzo superiore "Street" | PSB1 | 401,00 |
| Top triple clamp "Race" - Piastra di sterzo superiore "Race" | PSB1R | 332,00 |
| Engine protections - Protezioni motore | CP006C | 383,00 |
| Engine protections (SBK) - Protezioni motore (SBK) | CP006D | 406,00 |
| Unlifted handlebars - Semimanubri bassi | SM55B | 243,00 |
| Lifted handlebars - Semimanubri rialzati | SM55 | 243,00 |
| Brake lever - Leva freno | LB090 | 146,00 |
| Brake lever with remote adjuster - Leva freno con registro a sx | RALB090 | 254,00 |
| Clutch lever - Leva frizione | LC140 | 130,00 |
| Full clutch lever - Leva frizione completa | LCF | 173,00 |
| Adjustable full clutch lever - Leva frizione completa regolabile | LCFR | 231,00 |
| Levers kit - Kit leve | KL220 | 260,00 |
| Lever protection - Protezione leva | LPRR | 142,00 |
| Carbon lever protection - Protezione leva in carbonio | LPLITE_R | 270,00 |
| Tank cap - Tappo serbatoio | FC040 | 107,00 |
| 8ml Oil tank - Serbatoio olio 8ml | 0040 | 60,00 |
| Chain adjuster - Tendicatena | CHAD01 | 249,00 |
| Swing arms spools - Supporti cavalletto | 0026 | 29,00 |
| Swing arms spools "racing" - Supporti cavalletto "racing" | 0028 | 33,00 |
| Oil cap - Tappo olio | T004 | 35,00 |



PRICES WITHOUT VAT - PREZZI IVA ESCLUSA



* Handlebars to use the OEM triple clamp (include the steering plate bracelets)

* Semimanubri utilizzabili con la piastra di sterzo originale (Include i bracciali per la piastra di sterzo)

** Handlebars to use with Bonamici Racing top triple clamp (not include the clamps for steering plate)

** Semimanubri utilizzabili con la piastra di sterzo Bonamici Racing (non include la coppia di supporti ad arco per la piastra di sterzo)

*** The brake lever may touch with the knob on the instrument frame, when the motorcycle is understeer.

The plastic protection cannot be remounted on the clutch lever.

*** La leva freno quando la moto è sottosterzo, potrebbe toccare con il pomello sul telaio porta strumentazione.

Non è possibile rimontare la protezione in plastica sulla leva frizione.

DESCRIPTION - DESCRIZIONE

CODE - CODICE

€

| DESCRIPTION - DESCRIZIONE | CODE - CODICE | € |
|----------------------------------------------------------------------|---------------|--------|
| Rearset - Pedane | B007 | 635,00 |
| Top triple clamp "Street" - Piastra di sterzo superiore "Street" | PSB2 | 401,00 |
| Top triple clamp "Race" - Piastra di sterzo superiore "Race" | PSB2R | 332,00 |
| Engine protections 4pcs. - Protezioni motore 4pz. | CP086 | 470,00 |
| Engine protections "racing" 5 pcs. - Protezioni motore "racing" 5pz. | CP086B | 544,00 |
| Lifted handlebars* - Semimanubri rialzati* | SM55S1K | 355,00 |
| Lifted handlebars** - Semimanubri rialzati** | SM55S1KW | 243,00 |
| Brake lever*** - Leva freno*** | LB090 | 146,00 |
| Brake lever with remote adjuster - Leva freno con registro a sx | RALB090 | 254,00 |
| Clutch lever*** - Leva frizione*** | LC170 | 130,00 |
| Full clutch lever - Leva frizione completa | LCF | 173,00 |
| Adjustable full clutch lever - Leva frizione completa regolabile | LCFR | 231,00 |
| Levers kit*** - Kit leve*** | KL290 | 260,00 |
| Lever protection - Protezione leva | LPRR | 142,00 |
| Carbon lever protection - Protezione leva in carbonio | LPLITE_R | 270,00 |
| Dashboard protection - Protezione strumentazione | DCP08 | 191,00 |
| Tank cap - Tappo serbatoio | FC040 | 107,00 |
| 8ml Oil tank - Serbatoio olio 8ml | 0040 | 60,00 |
| Oil cap - Tappo olio | T004 | 35,00 |
| Chain adjuster - Tendicatena | CHAD09 | 249,00 |
| Swing arms spoils "racing" - Supporti cavalletto "racing" | 0028 | 33,00 |
| Block mirror - Tappi specchio | BM07 | 63,00 |
| Gear spacer support - Supporto distanziale cambio | DC_039B | 86,00 |

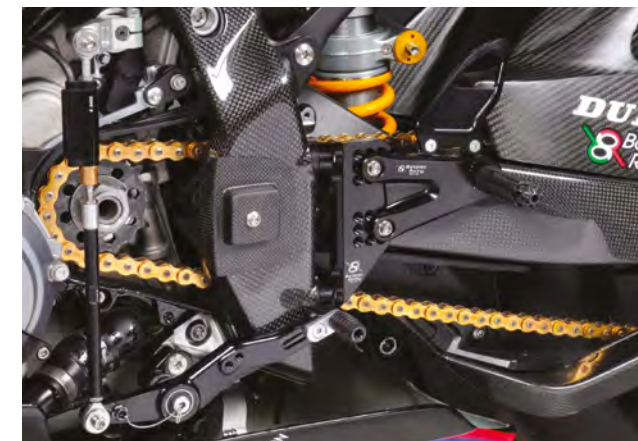
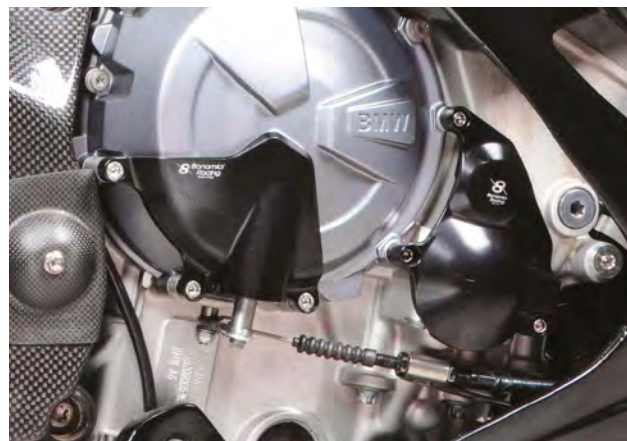

DESCRIPTION - DESCRIZIONE

CODE - CODICE

€

| DESCRIPTION - DESCRIZIONE | CODE - CODICE | € |
|----------------------------------------------------------------------|---------------|--------|
| Rearset - Pedane | B007 | 635,00 |
| Top triple clamp "Street" - Piastra di sterzo superiore "Street" | PSB3 | 401,00 |
| Top triple clamp "Race" - Piastra di sterzo superiore "Race" | PSB3R | 332,00 |
| Engine protections 4pcs. - Protezioni motore 4pz. | CP086 | 470,00 |
| Engine protections "racing" 5 pcs. - Protezioni motore "racing" 5pz. | CP086B | 544,00 |
| Lifted handlebars* - Semimanubri rialzati* | SM55S1K | 355,00 |
| Lifted handlebars** - Semimanubri rialzati** | SM55S1KW | 243,00 |
| Brake lever*** - Leva freno*** | LB090 | 146,00 |
| Brake lever with remote adjuster - Leva freno con registro a sx | RALB090 | 254,00 |
| Clutch lever*** - Leva frizione*** | LC170 | 130,00 |
| Full clutch lever - Leva frizione completa | LCF | 173,00 |
| Adjustable full clutch lever - Leva frizione completa regolabile | LCFR | 231,00 |
| Levers kit*** - Kit leve*** | KL290 | 260,00 |
| Lever protection - Protezione leva | LPRR | 142,00 |
| Carbon lever protection - Protezione leva in carbonio | LPLITE_R | 270,00 |
| Dashboard protection - Protezione strumentazione | DCP08 | 191,00 |
| Tank cap - Tappo serbatoio | FC040 | 107,00 |
| 8ml Oil tank - Serbatoio olio 8ml | 0040 | 60,00 |
| Oil cap - Tappo olio | T004 | 35,00 |
| Swing arms spools "racing" - Supporti cavalletto "racing" | 0028 | 33,00 |
| Block mirror - Tappi specchio | BM07 | 63,00 |
| Gear spacer support - Supporto distanziale cambio | DC_039B | 86,00 |



* Handlebars to use the OEM triple clamp (include the steering plate bracelets)

* Semimanubri utilizzabili con la piastra di sterzo originale (Include i bracciali per la piastra di sterzo)

** Handlebars to use with Bonamici Racing top triple clamp (not include the clamps for steering plate)

** Semimanubri utilizzabili con la piastra di sterzo Bonamici Racing (non include la coppia di supporti ad arco per la piastra di sterzo)

*** The brake lever may touch with the knob on the instrument frame, when the motorcycle is understeer.

The plastic protection cannot be remounted on the clutch lever.

*** La leva freno quando la moto è sottosterzo, potrebbe toccare con il pomello sul telaio porta strumentazione.

Non è possibile rimontare la protezione in plastica sulla leva frizione.

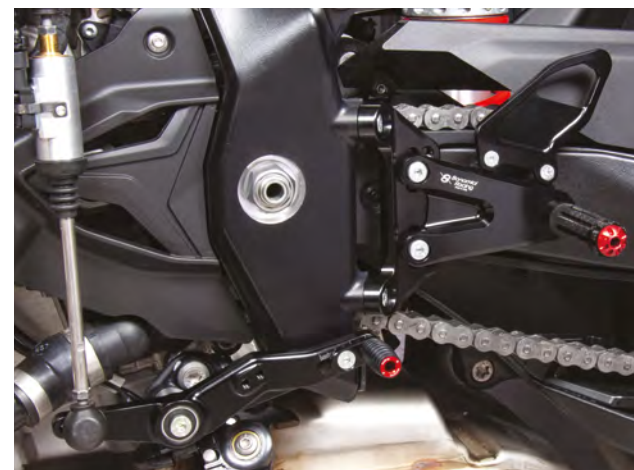
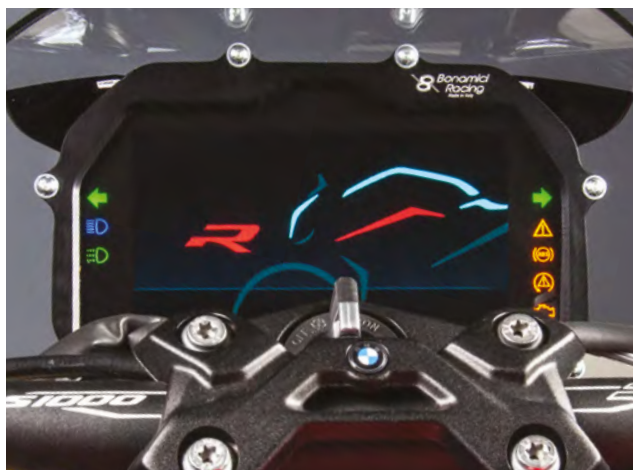

DESCRIPTION - DESCRIZIONE

CODE - CODICE

€

| | | |
|----------------------------------------------------------------------|---------|--------|
| Rearset - Pedane | B008 | 635,00 |
| Engine protections 4pcs. - Protezioni motore 4pz. | CP086 | 470,00 |
| Engine protections "racing" 5 pcs. - Protezioni motore "racing" 5pz. | CP086B | 544,00 |
| Brake lever - Leva freno | LB200 | 146,00 |
| Brake lever with remote adjuster - Leva freno con registro a sx | RALB200 | 254,00 |
| Clutch lever - Leva frizione | LC170 | 130,00 |
| Full clutch lever - Leva frizione completa | LCF | 173,00 |
| Adjustable full clutch lever - Leva frizione completa regolabile | LCFR | 231,00 |
| Levers kit - Kit leve | KL270 | 260,00 |
| Lever protection - Protezione leva | LPRR10 | 142,00 |
| Dashboard protection - Protezione strumentazione | DCP08 | 191,00 |
| Tank cap - Tappo serbatoio | FC040 | 107,00 |
| 8ml Oil tank - Serbatoio olio 8ml | 0040 | 60,00 |
| Oil cap - Tappo olio | T004 | 35,00 |
| Chain adjuster - Tendicatena | CHAD09 | 249,00 |
| Swing arms spools - Supporti cavalletto | 0026 | 29,00 |
| Swing arms spools "racing" - Supporti cavalletto "racing" | 0028 | 33,00 |
| Gear spacer support - Supporto distanziale cambio | DC_039B | 86,00 |



DESCRIPTION - DESCRIZIONE

CODE - CODICE

€

| | | |
|---------------------------------------------------|-------|--------|
| Rearset - Pedane | B009 | 713,00 |
| Engine protections 4pcs. - Protezioni motore 4pz. | CP116 | 470,00 |
| Brake lever - Leva freno | LB200 | 146,00 |
| Clutch lever - Leva frizione | LC170 | 130,00 |
| Levers kit - Kit leve | KL270 | 260,00 |
| Dashboard protection - Protezione strumentazione | DCP08 | 191,00 |
| Oil cap - Tappo olio | T004 | 35,00 |



PRICES WITHOUT VAT - PREZZI IVA ESCLUSA



DESCRIPTION - DESCRIZIONE

CODE - CODICE

€

| | | |
|-----------------------------------------------------------------|----------|--------|
| Rearset - Pedane | DV2 | 610,00 |
| Engine protections (for 959) - Protezioni motore (per 959) | CP009B | 370,00 |
| Unlifted handlebars ø53mm - Semimanubri bassi ø53mm | SM53B | 243,00 |
| Unlifted handlebars for 1199S - Semimanubri bassi per 1199S | SM53PA | 298,00 |
| Lifted handlebars ø53mm - Semimanubri rialzati ø53mm | SM53 | 243,00 |
| Lifted handlebars ø57mm - Semimanubri rialzati ø57mm | SM57 | 255,00 |
| Brake lever - Leva freno | LB140 | 146,00 |
| Brake lever with remote adjuster - Leva freno con registro a sx | RALB140 | 254,00 |
| Clutch lever - Leva frizione | LC061 | 143,00 |
| Levers kit - Kit leve | KL031 | 273,00 |
| Lever protection - Protezione leva | LPRR | 142,00 |
| Carbon lever protection - Protezione leva in carbonio | LPLITE_R | 270,00 |
| Tank cap - Tappo serbatoio | FC050 | 107,00 |
| Oil cap (899/1199) - Tappo olio (899/1199) | T003 | 35,00 |
| Oil cap (1299) - Tappo olio (1299) | T008 | 35,00 |
| 8ml Oil tank - Serbatoio olio 8ml | 0040 | 60,00 |
| Block mirror (899/1199) - Tappi specchio (899/1199) | BM01 | 63,00 |
| Block mirror (959/1299) - Tappi specchio (959/1299) | BM03 | 63,00 |



DESCRIPTION - DESCRIZIONE

CODE - CODICE

€

| | | |
|---------------------------------------------------------------------------------------------------|----------|--------|
| Rearset - Pedane | DV2 | 610,00 |
| Engine protections - Protezioni motore | CP105 | 370,00 |
| Handlebars with steering dumper bracket Semimanubri con bracciale per ammortizzatore di sterzo | SM53PV2 | 298,00 |
| Top triple clamp - Piastra di sterzo superiore | PSV2 | 501,00 |
| Dashboard protection - Protezione strumentazione | DGP11 | 179,00 |
| Brake lever - Leva freno | LB140 | 146,00 |
| Brake lever with remote adjuster - Leva freno con registro a sx | RALB140 | 254,00 |
| Clutch lever - Leva frizione | LC061 | 143,00 |
| Levers kit - Kit leve | KL031 | 273,00 |
| Lever protection - Protezione leva | LPRR | 142,00 |
| Carbon lever protection - Protezione leva in carbonio | LPLITE_R | 270,00 |
| Tank cap - Tappo serbatoio | FC050 | 107,00 |
| 8ml Oil tank - Serbatoio olio 8ml | 0040 | 60,00 |
| Oil cap - Tappo olio | T008 | 35,00 |
| Block mirror - Tappi specchio | BM06 | 63,00 |



PRICES WITHOUT VAT - PREZZI IVA ESCLUSA

DUCATI PANIGALE V4/V4S/V4R



DESCRIPTION - DESCRIZIONE

CODE - CODICE

€

| DESCRIPTION - DESCRIZIONE | CODE - CODICE | € |
|---------------------------------------------------------------------------------------------------------------------|---------------|--------|
| Rearset - Pedane | DV4 | 727,00 |
| Engine protections (V4/V4S) - Protezioni motore (V4/V4S) | CP081 | 359,00 |
| Engine protections (V4R) - Protezioni motore (V4R) | CP081B | 359,00 |
| Handlebars with steering dumper bracket (V4/V4S) Semimanubri con bracciale per ammortizzatore di sterzo (V4/V4S) | SM53PV4 | 312,00 |
| Handlebars with steering dumper bracket (V4R) Semimanubri con bracciale per ammortizzatore di sterzo (V4R) | SM53PV4R | 312,00 |
| Top triple clamp - Piastra di sterzo superiore | PSV4 | 501,00 |
| Dashboard protection - Protezione strumentazione | DCP03 | 179,00 |
| Brake lever - Leva freno | LB140 | 146,00 |
| Brake lever with remote adjuster - Leva freno con registro a sx | RALB140 | 254,00 |
| Clutch lever - Leva frizione | LC061 | 143,00 |
| Levers kit - Kit leve | KL031 | 273,00 |
| Lever protection - Protezione leva | LPRR | 142,00 |
| Carbon lever protection - Protezione leva in carbonio | LPLITE_R | 270,00 |
| Tank cap - Tappo serbatoio | FC050 | 107,00 |
| 8ml Oil tank - Serbatoio olio 8ml | 0040 | 60,00 |
| Oil cap - Tappo olio | T003 | 35,00 |
| Block mirror - Tappi specchio | BM06 | 63,00 |



DESCRIPTION - DESCRIZIONE

CODE - CODICE €

| | | |
|-----------------------------------------------------------------|----------|--------|
| Rearset - Pedane | DSTR2 | 727,00 |
| Engine protections - Protezioni motore | CP103 | 433,00 |
| Dashboard protection - Protezione strumentazione | DCP10 | 179,00 |
| Brake lever - Leva freno | LB140 | 146,00 |
| Brake lever with remote adjuster - Leva freno con registro a sx | RALB140 | 254,00 |
| Clutch lever - Leva frizione | LC061 | 143,00 |
| Levers kit - Kit leve | KL031 | 273,00 |
| Lever protection - Protezione leva | LPRR | 142,00 |
| Carbon lever protection - Protezione leva in carbonio | LPLITE_R | 270,00 |
| Tank cap - Tappo serbatoio | FC050 | 107,00 |
| 8ml Oil tank - Serbatoio olio 8ml | 0040 | 60,00 |
| Oil cap - Tappo olio | T003 | 35,00 |



PRICES WITHOUT VAT - PREZZI IVA ESCLUSA

HONDA CBR 1000 RR FIREBLADE 2017/2019

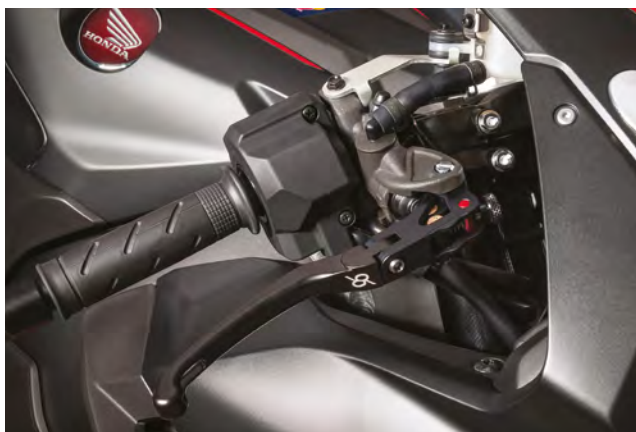

DESCRIPTION - DESCRIZIONE

CODE - CODICE

€

| DESCRIPTION - DESCRIZIONE | CODE - CODICE | € |
|------------------------------------------------------------------|---------------|--------|
| Rearset - Pedane | H013 | 483,00 |
| Rearset (with QS) - Pedane (con quickshifter) | H014 | 483,00 |
| Engine protections - Protezioni motore | CP066 | 445,00 |
| Unlifted handlebars - Semimanubri bassi | SM50B | 243,00 |
| Lifted handlebars - Semimanubri rialzati | SM50 | 243,00 |
| Top triple clamp "Street" - Piastra di sterzo superiore "Street" | PSH1 | 457,00 |
| Top triple clamp "Race" - Piastra di sterzo superiore "Race" | PSH1R | 332,00 |
| Brake lever - Leva freno | LB150 | 146,00 |
| Brake lever with remote adjuster - Leva freno con registro a sx | RALB150 | 254,00 |
| Clutch lever - Leva frizione | LC020 | 116,00 |
| Full clutch lever - Leva frizione completa | LCF | 173,00 |
| Adjustable full clutch lever - Leva frizione completa regolabile | LCFR | 231,00 |
| Levers kit - Kit leve | KL040 | 247,00 |
| Lever protection - Protezione leva | LPRR | 142,00 |
| Carbon lever protection - Protezione leva in carbonio | LPLITE_R | 270,00 |
| Tank cap - Tappo serbatoio | FC120 | 107,00 |
| Oil cap - Tappo olio | T003 | 35,00 |
| 8ml Oil tank - Serbatoio olio 8ml | 0040 | 60,00 |
| Chain protection - Pinna paracatena | ICP1 | 95,00 |
| Chain adjuster - Tencicatena | CHAD05 | 249,00 |
| Swing arms spools - Supporti cavalletto | 0026 | 29,00 |
| Swing arms spools "racing" - Supporti cavalletto "racing" | 0028 | 33,00 |
| Block mirror - Tappi specchio | BM05 | 63,00 |



DESCRIPTION - DESCRIZIONE

CODE - CODICE

€

| | | |
|------------------------------------------------------------------------|----------|--------|
| Rearset "Racing" - Pedane "Racing" | H015 | 537,00 |
| Rearset "Standard" - Pedane "Standard" | H016 | 574,00 |
| Gear spacer support - Supporto distanziale cambio | DC_040B | 98,00 |
| Engine protections - Protezioni motore | CP100 | 458,00 |
| Unlifted handlebars - Semimanubri bassi | SM50B | 243,00 |
| Top triple clamp - Piastra di sterzo superiore | PSH2 | 478,00 |
| Brake lever - Leva freno | LB150 | 146,00 |
| Brake lever (for SP model) - Leva freno (per modello SP) | LB110 | 146,00 |
| Brake lever with remote adjuster - Leva freno con registro a sx | RALB150 | 254,00 |
| Brake lever with remote adj. (SP) - Leva freno con registro a sx (SP.) | RALB110 | 254,00 |
| Clutch lever - Leva frizione | LC020 | 116,00 |
| Full clutch lever - Leva frizione completa | LCF | 173,00 |
| Adjustable full clutch lever - Leva frizione completa regolabile | LCFR | 231,00 |
| Levers kit - Kit leve | KL040 | 247,00 |
| Levers kit (for SP model) - Kit leve (per modello SP) | KL310 | 247,00 |
| Lever protection - Protezione leva | LPRR | 142,00 |
| Carbon lever protection - Protezione leva in carbonio | LPLITE_R | 270,00 |
| Tank cap - Tappo serbatoio | FC120 | 107,00 |
| Oil cap - Tappo olio | T003 | 35,00 |
| 8ml Oil tank - Serbatoio olio 8ml | 0040 | 60,00 |
| Chain protection - Pinna paracatena | ICP1 | 95,00 |
| Chain adjuster - Tindicatena | CHAD10 | 249,00 |
| Dashboard protection - Protezione strumentazione | DCP09 | 182,00 |



DESCRIPTION - DESCRIZIONE

CODE - CODICE

€

| | | |
|-----------------------------------------------------------|------|-------|
| Swing arms spools - Supporti cavalletto | 0026 | 29,00 |
| Swing arms spools "racing" - Supporti cavalletto "racing" | 0028 | 33,00 |
| Block mirror - Tappi specchio | BM05 | 63,00 |



DESCRIPTION - DESCRIZIONE

CODE - CODICE

€

| | | |
|----------------------------------------------------------------------------------------|----------|--------|
| Rearset - Pedane | H017 | 429,00 |
| Engine protections - Protezioni motore | CP034 | 258,00 |
| Brake lever - Leva freno | LB180 | 146,00 |
| Brake lever with remote adjuster - Leva freno con registro a sx | RALB180 | 254,00 |
| Brake lever with Racing remote adjuster - Leva freno con registro Racing a sx | RALB180R | 360,00 |
| Clutch lever - Leva frizione | LC220 | 116,00 |
| Full clutch lever - Leva frizione completa | LCF | 173,00 |
| Adjustable full clutch lever - Leva frizione completa regolabile | LCFR | 231,00 |
| Levers kit - Kit leve | KL350 | 247,00 |
| Lever protection (brake side) - Protezione leva (lato freno) | LPRR | 142,00 |
| Lever protection (clutch side) - Protezione leva (lato frizione) | LPRL | 142,00 |
| Lever protection (brake side) short version Protezione leva (lato freno) tipo corto | LPRC | 142,00 |
| Carbon lever protection - Protezione leva in carbonio | LPLITE_R | 270,00 |
| Tank cap - Tappo serbatoio | FC120 | 107,00 |
| Oil cap - Tappo olio | T003 | 35,00 |
| Chain protection with carbon plate - Paracatena con pinna in carbonio | ICP1 | 95,00 |
| Chain protection with aluminium plate - Paracatena con pinna in alluminio | ICP2 | 63,00 |



DESCRIPTION - DESCRIZIONE

CODE - CODICE

€

| | | |
|------------------------------------------------------------------|----------|--------|
| Rearset (normal shifting) - Pedane (cambio normale) | K015 | 408,00 |
| Engine protections - Protezioni motore | CP012 | 260,00 |
| Unlifted handlebars - Semimanubri bassi | SM50B | 243,00 |
| Lifted handlebars - Semimanubri rialzati | SM50 | 243,00 |
| Top triple clamp "Street" - Piastra di sterzo superiore "Street" | PSK1 | 379,00 |
| Top triple clamp "Race" - Piastra di sterzo superiore "Race" | PSK1R | 356,00 |
| Brake lever - Leva freno | LB110 | 146,00 |
| Brake lever with remote adjuster - Leva freno con registro a sx | RALB110 | 254,00 |
| Clutch lever - Leva frizione | LC040 | 116,00 |
| Full clutch lever - Leva frizione completa | LCF | 173,00 |
| Adjustable full clutch lever - Leva frizione completa regolabile | LCFR | 231,00 |
| Levers kit - Kit leve | KL210 | 247,00 |
| Lever protection - Protezione leva | LPRR | 142,00 |
| Carbon lever protection - Protezione leva in carbonio | LPLITE_R | 270,00 |
| Tank cap - Tappo serbatoio | FC070 | 107,00 |
| Oil cap - Tappo olio | T002 | 35,00 |
| 8ml Oil tank - Serbatoio olio 8ml | 0040 | 60,00 |
| Chain protection - Pinna paracatena | ICP1 | 95,00 |
| Chain adjuster - Tendicatena | CHAD02 | 249,00 |
| Swing arms spools - Supporti cavalletto | 0026 | 29,00 |
| Swing arms spools "racing" - Supporti cavalletto "racing" | 0028 | 33,00 |



PRICES WITHOUT VAT - PREZZI IVA ESCLUSA



DESCRIPTION - DESCRIZIONE

CODE - CODICE

€

| DESCRIPTION - DESCRIZIONE | CODE - CODICE | € |
|-------------------------------------------------------------------------------|---------------|--------|
| Rearset - Pedane | K021 | 635,00 |
| Engine protections - Protezioni motore | CP012 | 260,00 |
| Unlifted handlebars - Semimanubri bassi | SM50B | 243,00 |
| Lifted handlebars - Semimanubri rialzati | SM50 | 243,00 |
| Dashboard protection - Protezione strumentazione | DCP20 | 206,00 |
| Top triple clamp "Street" - Piastra di sterzo superiore "Street" | PSK1 | 379,00 |
| Top triple clamp "Race" - Piastra di sterzo superiore "Race" | PSK1R | 356,00 |
| Brake lever - Leva freno | LB110 | 146,00 |
| Brake lever with remote adjuster - Leva freno con registro a sx | RALB110 | 254,00 |
| Brake lever with Racing remote adjuster - Leva freno con registro Racing a sx | RALB110R | 360,00 |
| Clutch lever - Leva frizione | LC040 | 116,00 |
| Full clutch lever - Leva frizione completa | LCF | 173,00 |
| Adjustable full clutch lever - Leva frizione completa regolabile | LCFR | 231,00 |
| Levers kit - Kit leve | KL210 | 247,00 |
| Lever protection - Protezione leva | LPRR | 142,00 |
| Carbon lever protection - Protezione leva in carbonio | LPLITE_R | 270,00 |
| Tank cap - Tappo serbatoio | FC170 | 107,00 |
| Oil cap - Tappo olio | T002 | 35,00 |
| 8ml Oil tank - Serbatoio olio 8ml | 0040 | 60,00 |
| Chain protection - Pinna paracatena | ICP1 | 95,00 |
| Chain adjuster - Tendicatena | CHAD02 | 249,00 |
| Swing arms spools - Supporti cavalletto | 0026 | 29,00 |
| Swing arms spools "racing" - Supporti cavalletto "racing" | 0028 | 33,00 |

PRICES WITHOUT VAT - PREZZI IVA ESCLUSA



DESCRIPTION - DESCRIZIONE

CODE - CODICE

€

| | | |
|------------------------------------------------------------------|-----------|--------|
| Rearset - Pedane | K019 | 420,00 |
| Engine protections - Protezioni motore | CP078 | 347,00 |
| 30mm lifted handlebars* - Semimanubri rialzati di 30mm* | SM41_30 | 243,00 |
| Brake lever - Leva freno | LB180 | 146,00 |
| Brake lever with remote adjuster - Leva freno con registro a sx | RALB180 | 254,00 |
| Clutch lever - Leva frizione | LC160 | 116,00 |
| Full clutch lever - Leva frizione completa | LCF | 173,00 |
| Adjustable full clutch lever - Leva frizione completa regolabile | LCFR | 231,00 |
| Levers kit - Kit leve | KL260 | 247,00 |
| Lever protection - Protezione leva | LPRR | 142,00 |
| Carbon lever protection - Protezione leva in carbonio | LP_LITE_R | 270,00 |
| Tank cap - Tappo serbatoio | FC170 | 107,00 |
| Oil cap - Tappo olio | T008 | 35,00 |
| 8ml Oil tank - Serbatoio olio 8ml | 0040 | 60,00 |
| Chain protection - Pinna paracatena | ICP1 | 95,00 |
| Swing arms spools - Supporti cavalletto | 0026 | 29,00 |
| Swing arms spools "racing" - Supporti cavalletto "racing" | 0028 | 33,00 |

*It need to modify the original fairing
*Occorre modificare le carene originali



PRICES WITHOUT VAT - PREZZI IVA ESCLUSA



DESCRIPTION - DESCRIZIONE

CODE - CODICE

€

| | | |
|------------------------------------------------------------------|----------|--------|
| Rearset - Pedane | K018 | 483,00 |
| Full clutch lever - Leva frizione completa | LCF | 173,00 |
| Adjustable full clutch lever - Leva frizione completa regolabile | LCFR | 231,00 |
| Lever protection - Protezione leva | LPRR | 142,00 |
| Carbon lever protection - Protezione leva in carbonio | LPLITE_R | 270,00 |
| Tank cap - Tappo serbatoio | FC170 | 107,00 |
| 8ml Oil tank - Serbatoio olio 8ml | 0040 | 60,00 |
| Swing arm spools - Supporti cavalletto | 0026 | 29,00 |
| Swing arms spools "racing" - Supporti cavalletto "racing" | 0028 | 33,00 |



DESCRIPTION - DESCRIZIONE

CODE - CODICE

€

| | | |
|------------------------------------------------------------------|----------|--------|
| Rearset - Pedane | K017 | 408,00 |
| Full clutch lever - Leva frizione completa | LCF | 173,00 |
| Adjustable full clutch lever - Leva frizione completa regolabile | LCFR | 231,00 |
| Lever protection - Protezione leva | LPRR | 142,00 |
| Carbon lever protection - Protezione leva in carbonio | LPLITE_R | 270,00 |
| Tank cap - Tappo serbatoio | FC170 | 107,00 |
| 8ml Oil tank - Serbatoio olio 8ml | 0040 | 60,00 |
| Swing arm spools - Supporti cavalletto | 0026 | 29,00 |
| Swing arms spools "racing" - Supporti cavalletto "racing" | 0028 | 33,00 |



PRICES WITHOUT VAT - PREZZI IVA ESCLUSA



DESCRIPTION - DESCRIZIONE

CODE - CODICE

€

| | | |
|------------------------------------------------------------------|----------|--------|
| Rearset - Pedane | KT01 | 519,00 |
| Engine protections (*14/*16) - Protezioni motore (*14/*16) | CP057 | 347,00 |
| Engine protections (*17/*20) - Protezioni motore (*17/*20) | CP089 | 347,00 |
| Full clutch lever - Leva frizione completa | LCF | 173,00 |
| Adjustable full clutch lever - Leva frizione completa regolabile | LCFR | 231,00 |
| Lever protection - Protezione leva | LPRR | 142,00 |
| Carbon lever protection - Protezione leva in carbonio | LPLITE_R | 270,00 |
| Tank cap - Tappo serbatoio | FC200 | 107,00 |
| 8ml Oil tank - Serbatoio olio 8ml | 0040 | 60,00 |
| Chain protection - Pinna paracatena | ICP1 | 95,00 |
| Swing arms spools - Supporti cavalletto | 0026 | 29,00 |
| Swing arms spools "racing" - Supporti cavalletto "racing" | 0028 | 33,00 |

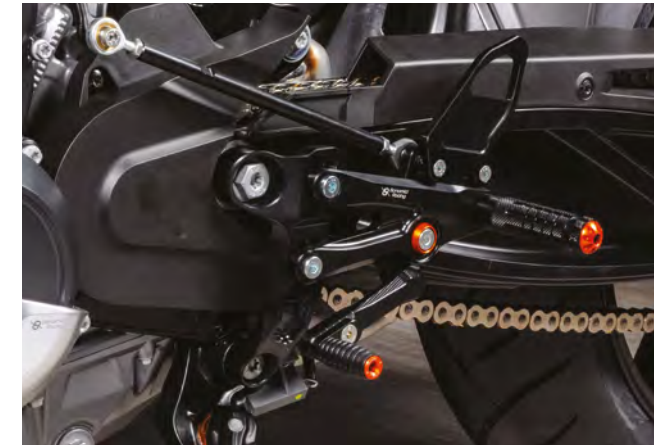

DESCRIPTION - DESCRIZIONE

CODE - CODICE

€

| | | |
|----------------------------------------------------------|----------|--------|
| Rearset - Pedane | KT04 | 499,00 |
| Engine protections - Protezioni motore (Duke 790) | CP093 | 359,00 |
| Engine protections - Protezioni motore (Duke 890) | CP093B | 359,00 |
| Levers kit - Kit leve | KL300 | 260,00 |
| Brake lever - Leva freno | LB190 | 146,00 |
| Clutch lever - Leva frizione | LC180 | 130,00 |
| Lever protection brake side - Protezione leva DX | LP RR | 142,00 |
| Lever protection clutch side - Protezione leva SX | LP RL | 142,00 |
| Carbon lever protection - Protezione leva in carbonio | LPLITE_R | 270,00 |
| Tank cap - Tappo serbatoio | FC200 | 107,00 |
| 8ml Oil tank - Serbatoio olio 8ml | 0040 | 60,00 |
| Swing arm spools 10 x 1,5 - Supporti cavalletto 10 x 1,5 | 0031 | 33,00 |



PRICES WITHOUT VAT - PREZZI IVA ESCLUSA



DESCRIPTION - DESCRIZIONE

CODE - CODICE

€

| | | |
|------------------------------------------------------------------|----------|--------|
| Rearset - Pedane | KT05 | 485,00 |
| Engine protections - Protezioni motore | CP060 | 328,00 |
| Levers kit - Kit leve | KL280 | 260,00 |
| Brake lever - Leva freno | LB110 | 146,00 |
| Clutch lever - Leva frizione | LC200 | 130,00 |
| Full clutch lever - Leva frizione completa | LCF | 173,00 |
| Adjustable full clutch lever - Leva frizione completa regolabile | LCFR | 231,00 |
| Lever protection - Protezione leva | LPRR | 142,00 |
| Carbon lever protection - Protezione leva in carbonio | LPLITE_R | 270,00 |
| Tank cap - Tappo serbatoio | FC210 | 107,00 |
| 8ml Oil tank - Serbatoio olio 8ml | 0040 | 60,00 |

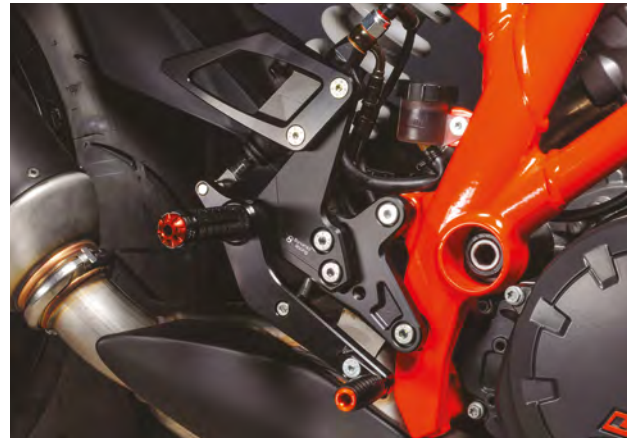

DESCRIPTION - DESCRIZIONE

CODE - CODICE

€

| | | |
|------------------------------------------------------------------|----------|--------|
| Rearset - Pedane | KT03 | 455,00 |
| Engine protections - Protezioni motore | CP060 | 328,00 |
| Full clutch lever - Leva frizione completa | LCF | 173,00 |
| Adjustable full clutch lever - Leva frizione completa regolabile | LCFR | 231,00 |
| Lever protection - Protezione leva | LPRR | 142,00 |
| Carbon lever protection - Protezione leva in carbonio | LPLITE_R | 270,00 |
| Tank cap - Tappo serbatoio | FC210 | 107,00 |
| 8ml Oil tank - Serbatoio olio 8ml | 0040 | 60,00 |



PRICES WITHOUT VAT - PREZZI IVA ESCLUSA



DESCRIPTION - DESCRIZIONE

CODE - CODICE

€

| | | |
|------------------------------------------------------------------|----------|--------|
| Rearset (normal shifting) - Pedane (cambio normale) | MV02 | 531,00 |
| Rearset (reverse shifting) - Pedane (cambio rovesciato) | MV02R | 531,00 |
| Engine protections - Protezioni motore | CP021 | 310,00 |
| Lifted handlebars - Semimanubri rialzati | SM50 | 243,00 |
| Unlifted handlebars - Semimanubri bassi | SM50B | 243,00 |
| Brake lever - Leva freno | LB090 | 146,00 |
| Brake lever with remote adjuster - Leva freno con registro a sx | RALB090 | 254,00 |
| Clutch lever - Leva frizione | LC110 | 116,00 |
| Full clutch lever - Leva frizione completa | LCF | 173,00 |
| Adjustable full clutch lever - Leva frizione completa regolabile | LCFR | 231,00 |
| Levers kit - Kit leve | KL200 | 247,00 |
| Lever protection - Protezione leva | LPRR | 142,00 |
| Carbon lever protection - Protezione leva in carbonio | LPLITE_R | 270,00 |
| Tank cap - Tappo serbatoio | FC090 | 107,00 |
| 8ml Oil tank - Serbatoio olio 8ml | 0040 | 60,00 |



DESCRIPTION - DESCRIZIONE

CODE - CODICE

€

| DESCRIPTION - DESCRIZIONE | CODE - CODICE | € |
|------------------------------------------------------------------|---------------|--------|
| Rearset - Pedane | S011 | 483,00 |
| Engine protections - Protezioni motore | CP070 | 396,00 |
| Unlifted handlebars - Semimanubri bassi | SM50B | 243,00 |
| Lifted handlebars - Semimanubri rialzati | SM50 | 243,00 |
| Dashboard protection - Protezione strumentazione | DCP05 | 191,00 |
| Top triple clamp "Street" - Piastra di sterzo superiore "Street" | PSS1 | 379,00 |
| Top triple clamp "Race" - Piastra di sterzo superiore "Race" | PSS1R | 332,00 |
| Brake lever - Leva freno | LB090 | 146,00 |
| Brake lever with remote adjuster - Leva freno con registro a sx | RALB090 | 254,00 |
| Clutch lever - Leva frizione | LC090 | 116,00 |
| Full clutch lever - Leva frizione completa | LCF | 173,00 |
| Adjustable full clutch lever - Leva frizione completa regolabile | LCFR | 231,00 |
| Levers kit - Kit leve | KL170 | 247,00 |
| Lever protection - Protezione leva | LPRR | 142,00 |
| Carbon lever protection - Protezione leva in carbonio | LPLITE_R | 270,00 |
| Tank cap - Tappo serbatoio | FC080 | 107,00 |
| Oil cap - Tappo olio | T005 | 35,00 |
| 8ml Oil tank - Serbatoio olio 8ml | 0040 | 60,00 |
| Chain protection - Pinna paracatena | ICP1 | 95,00 |
| Chain adjuster - Tendicatena | CHAD06 | 249,00 |
| Swing arms spools - Supporti cavalletto | 0026 | 29,00 |
| Swing arms spools "racing" - Supporti cavalletto "racing" | 0028 | 33,00 |
| Block mirror - Tappi specchio | BM04 | 63,00 |



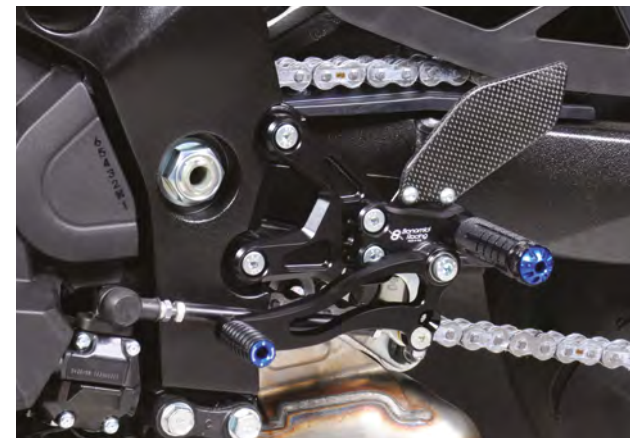

DESCRIPTION - DESCRIZIONE

CODE - CODICE

€

| | | |
|----------------------------------------------------------------------------|----------|--------|
| Rearset - Pedane | S013 | 391,00 |
| Brake lever - Leva freno | LB201 | 146,00 |
| Brake lever with remote adjuster - Leva freno con registro a sx | RALB201 | 254,00 |
| Clutch lever - Leva frizione | LC210 | 116,00 |
| Levers kit - Kit leve | KL330 | 247,00 |
| Lever protection (adaptor code ADL17) - Paraleva (adattatore codice ADL17) | LPRR | 142,00 |
| Carbon lever protection - Protezione leva in carbonio | LPLITE_R | 270,00 |
| Dashboard protection - Protezione strumentazione | DCP05 | 191,00 |
| Tank cap - Tappo serbatoio | FC080 | 107,00 |
| 8ml Oil tank - Serbatoio olio 8ml | 0040 | 60,00 |
| Oil cap - Tappo olio | T005 | 35,00 |
| Chain adjuster - Tencicatena | CHAD06 | 249,00 |
| Swing arms spools - Supporti cavalletto | 0026 | 29,00 |
| Swing arms spools "racing" - Supporti cavalletto "racing" | 0028 | 33,00 |

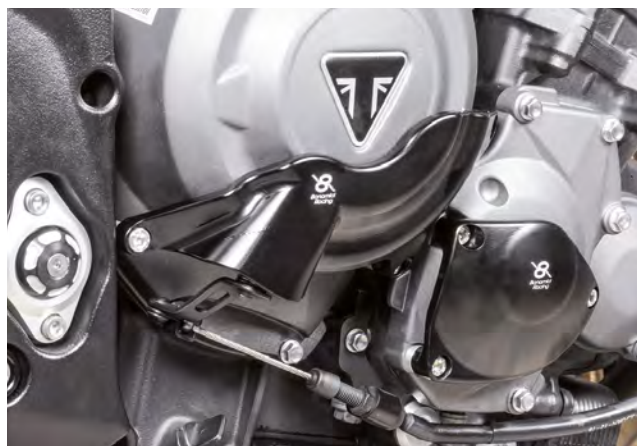

DESCRIPTION - DESCRIZIONE

CODE - CODICE

€

| | | |
|------------------------------------------------------------------|----------|--------|
| Rearset - Pedane | TH06 | 531,00 |
| Engine protections - Protezioni motore | CP074 | 359,00 |
| Full clutch lever - Leva frizione completa | LCF | 173,00 |
| Adjustable full clutch lever - Leva frizione completa regolabile | LCFR | 231,00 |
| Lever protection - Protezione leva | LPRR | 142,00 |
| Carbon lever protection - Protezione leva in carbonio | LPLITE_R | 270,00 |
| Tank cap - Tappo serbatoio | FC220 | 107,00 |
| 8ml Oil tank - Serbatoio olio 8ml | 0040 | 60,00 |
| Swing arm spools - Supporti cavalletto | 0026 | 29,00 |
| Swing arms spools "racing" - Supporti cavalletto "racing" | 0028 | 33,00 |



PRICES WITHOUT VAT - PREZZI IVA ESCLUSA

TRIUMPH SPEED TRIPLE 1050 2011/ 2020



DESCRIPTION - DESCRIZIONE

CODE - CODICE

€

| | | |
|------------------------------------------------------------------|----------|--------|
| Rearset (normal shifting) - Pedane (cambio normale) | TH05 | 435,00 |
| Rearset (reverse shifting) - Pedane (cambio rovesciato) | TH05R | 435,00 |
| Brake lever - Leva freno (for models from 2011 to 2017) | LB110 | 146,00 |
| Brake lever with remote adjuster - Leva freno con registro a sx | RALB110 | 254,00 |
| Clutch lever - Leva frizione (for models from 2011 to 2017) | LC080 | 116,00 |
| Levers kit - Kit leve (for models from 2011 to 2017) | KL180 | 247,00 |
| Full clutch lever - Leva frizione completa | LCF | 173,00 |
| Adjustable full clutch lever - Leva frizione completa regolabile | LCFR | 231,00 |
| Lever protection - Paraleva | LPRR | 142,00 |
| Carbon lever protection - Protezione leva in carbonio | LPLITE_R | 270,00 |
| Tank cap - Tappo serbatoio | FC220 | 107,00 |
| 8ml Oil tank - Serbatoio olio 8ml | 0040 | 60,00 |
| Oil cap - Tappo olio | T003 | 35,00 |



DESCRIPTION - DESCRIZIONE

CODE - CODICE €

| | | |
|-------------------------------------------------------------------------------|----------|--------|
| Rearset - Pedane | TH08 | 537,00 |
| Engine protections - Protezioni motore | CP119 | 290,00 |
| Brake lever - Leva freno | LB210 | 116,00 |
| Brake lever with remote adjuster - Leva freno con registro a sx | RALB210 | 215,00 |
| Brake lever with Racing remote adjuster - Leva freno con registro Racing a sx | RALB210R | 346,00 |
| Clutch lever - Leva frizione | LC230 | 116,00 |
| Full clutch lever - Leva frizione completa | LCF | 173,00 |
| Adjustable full clutch lever - Leva frizione completa regolabile | LCFR | 231,00 |
| Levers kit - Kit leve | KL360 | 221,00 |
| Lever protection - Protezione leva | LPRR | 142,00 |
| Carbon lever protection - Protezione leva in carbonio | LPLITE_R | 270,00 |
| Oil cap - Tappo olio | T009 | 35,00 |
| 8ml Oil tank - Serbatoio olio 8ml | 0040 | 60,00 |





DESCRIPTION - DESCRIZIONE

CODE - CODICE €

| | | |
|-------------------------------------------------------------------------------|----------|--------|
| Rearset - Pedane | TH07 | 537,00 |
| Engine protections - Protezioni motore | CP119 | 290,00 |
| Top triple clamp - Piastra di sterzo superiore* | PST1 | 478,00 |
| Brake lever - Leva freno | LB210 | 116,00 |
| Brake lever with remote adjuster - Leva freno con registro a sx | RALB210 | 215,00 |
| Brake lever with Racing remote adjuster - Leva freno con registro Racing a sx | RALB210R | 346,00 |
| Clutch lever - Leva frizione | LC230 | 116,00 |
| Full clutch lever - Leva frizione completa | LCF | 173,00 |
| Adjustable full clutch lever - Leva frizione completa regolabile | LCFR | 231,00 |
| Levers kit - Kit leve | KL360 | 221,00 |
| Lever protection - Paraleva | LPRR | 142,00 |
| Carbon lever protection - Protezione leva in carbonio | LPLITE_R | 270,00 |
| Oil cap - Tappo olio | T009 | 35,00 |
| 8ml Oil tank - Serbatoio olio 8ml | 0040 | 60,00 |

(*) Equipped with Bonamici Racing Nut, when mounting it is recommended to apply a light layer of grease.

(*) Dotata del dado Bonamici Racing, si consiglia al momento del montaggio del dado di applicare un leggero strato di grasso



DESCRIPTION - DESCRIZIONE

CODE - CODICE

€

| DESCRIPTION - DESCRIZIONE | CODE - CODICE | € |
|------------------------------------------------------------------|---------------|--------|
| Rearset - Pedane | Y011 | 519,00 |
| Bracket for Akrapovic exhaust - Staffa per scarico Akrapovic | SS_007A | 83,00 |
| Engine protections - Protezioni motore | CP047 | 445,00 |
| Unlifted handlebars - Semimanubri bassi | SM50B | 243,00 |
| Top triple clamp "Street" - Piastra di sterzo superiore "Street" | PSY1 | 379,00 |
| Top triple clamp "Race" - Piastra di sterzo superiore "Race" | PSY1R | 332,00 |
| Dashboard protection - Protezione strumentazione | DCP04 | 179,00 |
| Brake lever - Leva freno | LB101 | 146,00 |
| Clutch lever - Leva frizione | LC010 | 116,00 |
| Full clutch lever - Leva frizione completa | LCF | 173,00 |
| Adjustable full clutch lever - Leva frizione completa regolabile | LCFR | 231,00 |
| Levers kit - Kit leve | KL231 | 247,00 |
| Lever protection - Paraleva | LPRR | 142,00 |
| Carbon lever protection - Protezione leva in carbonio | LPLITE_R | 270,00 |
| Tank cap - Tappo serbatoio | FC110 | 107,00 |
| Oil cap - Tappo olio | T007 | 35,00 |
| 8ml Oil tank - Serbatoio olio 8ml | 0040 | 60,00 |
| Chain protection - Pinna paracatena | ICP1 | 95,00 |
| Chain adjuster - Tendicatena | CHAD03 | 249,00 |
| Swing arms spools - Supporti cavalletto | 0025 | 29,00 |
| Swing arms spools "racing" - Supporti cavalletto "racing" | 0027 | 33,00 |



PRICES WITHOUT VAT - PREZZI IVA ESCLUSA

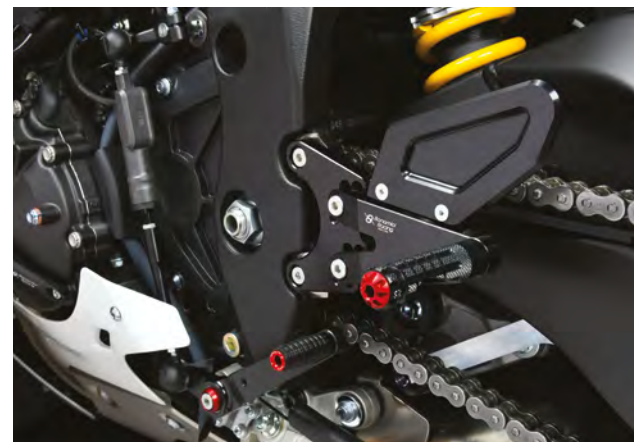

DESCRIPTION - DESCRIZIONE

CODE - CODICE

€

| | | |
|------------------------------------------------------------------|----------|--------|
| Rearset - Pedane | Y011 | 519,00 |
| Bracket for Akrapovic exhaust - Staffa per scarico Akrapovic | SS_007A | 83,00 |
| Engine protections - Protezioni motore | CP047 | 445,00 |
| Unlifted handlebars - Semimanubri bassi | SM50B | 243,00 |
| Top triple clamp "Street" - Piastra di sterzo superiore "Street" | PSY1 | 379,00 |
| Top triple clamp "Race" - Piastra di sterzo superiore "Race" | PSY1R | 332,00 |
| Dashboard protection - Protezione strumentazione | DCP04 | 179,00 |
| Brake lever - Leva freno | LB101 | 146,00 |
| Clutch lever - Leva frizione | LC010 | 116,00 |
| Full clutch lever - Leva frizione completa | LCF | 173,00 |
| Adjustable full clutch lever - Leva frizione completa regolabile | LCFR | 231,00 |
| Levers kit - Kit leve | KL231 | 247,00 |
| Lever protection - Paraleva | LPRR | 142,00 |
| Carbon lever protection - Protezione leva in carbonio | LPLITE_R | 270,00 |
| Tank cap - Tappo serbatoio | FC110 | 107,00 |
| Oil cap - Tappo olio | T007 | 35,00 |
| 8ml Oil tank - Serbatoio olio 8ml | 0040 | 60,00 |
| Chain protection - Pinna paracatena | ICP1 | 95,00 |
| Chain adjuster - Tendicatena | CHAD11 | 249,00 |
| Swing arms spools - Supporti cavalletto | 0025 | 29,00 |
| Swing arms spools "racing" - Supporti cavalletto "racing" | 0027 | 33,00 |



DESCRIPTION - DESCRIZIONE

CODE - CODICE

€

| DESCRIPTION - DESCRIZIONE | CODE - CODICE | € |
|------------------------------------------------------------------|---------------|--------|
| Rearset - Pedane | Y013 | 455,00 |
| Engine protections - Protezioni motore | CP025 | 402,00 |
| Unlifted handlebars - Semimanubri bassi | SM50B | 243,00 |
| Lifted handlebars - Semimanubri rialzati | SM50 | 243,00 |
| Top triple clamp "Street" - Piastra di sterzo superiore "Street" | PSY2 | 379,00 |
| Top triple clamp "Race" - Piastra di sterzo superiore "Race" | PSY2R | 332,00 |
| Brake lever - Leva freno | LB100 | 146,00 |
| Brake lever with remote adjuster - Leva freno con registro a sx | RALB100 | 254,00 |
| Clutch lever - Leva frizione | LC010 | 116,00 |
| Full clutch lever - Leva frizione completa | LCF | 173,00 |
| Adjustable full clutch lever - Leva frizione completa regolabile | LCFR | 231,00 |
| Levers kit - Kit leve | KL230 | 247,00 |
| Lever protection - Paraleva | LPRR | 142,00 |
| Carbon lever protection - Protezione leva in carbonio | LPLITE_R | 270,00 |
| Tank cap - Tappo serbatoio | FC110 | 107,00 |
| Oil cap - Tappo olio | T007 | 35,00 |
| 8ml Oil tank - Serbatoio olio 8ml | 0040 | 60,00 |
| Chain protection - Pinna paracatena | ICP1 | 95,00 |
| Chain adjuster - Tendicatena | CHAD07 | 249,00 |
| Swing arms spools - Supporti cavalletto | 0025 | 29,00 |
| Swing arms spools "racing" - Supporti cavalletto "racing" | 0027 | 33,00 |
| Gear spacer support - Supporto distanziale cambio | DC_037B | 86,00 |



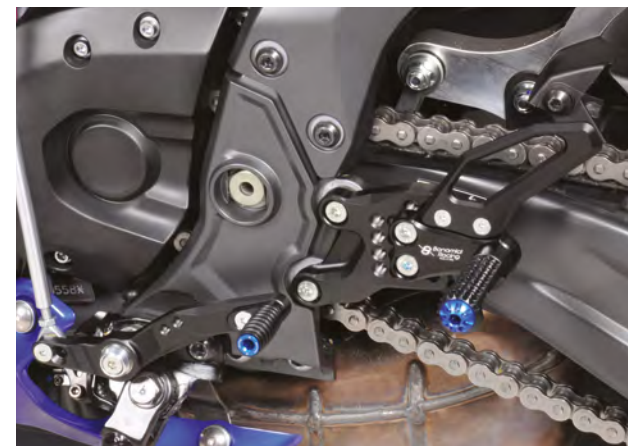

DESCRIPTION - DESCRIZIONE

CODE - CODICE

€

| | | |
|---------------------------------------------------------------------------------------------------------------------------------------------------------------------|----------|--------|
| Rearsets - Pedane | Y015 | 455,00 |
| Unlifted handlebars - Semimanubri bassi | SM50B | 243,00 |
| Top triple clamp "Street" - Piastra di sterzo superiore "Street" | PSY3 | 379,00 |
| Top triple clamp "Race" - Piastra di sterzo superiore "Race" | PSY3R | 346,00 |
| Top triple clamp Nut - Dado piastra di sterzo superiore | DD3 | 45,00 |
| Dashboard protection - Protezione strumentazione | DCP16 | 184,00 |
| Brake lever - Leva freno It can only be mounted on Bonamici Racing handlebars Code SM50B Può essere montata solo sui semimanubri Bonamici Racing Codice SM50B | LB220 | 156,00 |
| Brake lever with remote adjuster - Leva freno con registro a sx | RALB220 | 264,00 |
| Clutch lever - Leva frizione | LC010 | 116,00 |
| Full clutch lever - Leva frizione completa | LCF | 173,00 |
| Adjustable full clutch lever - Leva frizione completa regolabile | LCFR | 231,00 |
| Levers kit - Kit leve | KL340 | 272,00 |
| Lever protection - Paraleva | LPRR | 142,00 |
| Carbon lever protection - Protezione leva in carbonio | LPLITE_R | 270,00 |
| Remote adjuster - Registro remoto | 00BR | 99,00 |
| Racing Remote adjuster - Registro remoto "racing" | RRP_BR | 167,00 |
| Tank cap - Tappo serbatoio | FC110 | 107,00 |
| Oil cap - Tappo olio | T007 | 35,00 |
| 8ml Oil tank - Serbatoio olio 8ml | 0040 | 60,00 |
| Swing arms spools - Supporti cavalletto | 0025 | 29,00 |
| Swing arms spools "racing" - Supporti cavalletto "racing" | 0027 | 33,00 |



DESCRIPTION - DESCRIZIONE

CODE - CODICE

€

| | | |
|------------------------------------------------------------------|----------|--------|
| Rearset - Pedane | Y012 | 391,00 |
| Engine protections - Protezioni motore | CP054 | 359,00 |
| Lifted handlebars ('15/'18) - Semimanubri rialzati ('15/'18) | SM41 | 231,00 |
| Lifted handlebars ('19/ >) - Semimanubri rialzati ('19/ >) | SM47 | 243,00 |
| Dashboard protection * - Protezione strumentazione * | DCP07 | 179,00 |
| Brake lever - Leva freno | LB170 | 146,00 |
| Brake lever with remote adjuster - Leva freno con registro a sx | RALB170 | 254,00 |
| Clutch lever - Leva frizione | LC150 | 116,00 |
| Full clutch lever - Leva frizione completa | LCF | 173,00 |
| Adjustable full clutch lever - Leva frizione completa regolabile | LCFR | 231,00 |
| Levers kit - Kit leve | KL250 | 247,00 |
| Lever protection - Paraleva | LPRR | 142,00 |
| Carbon lever protection - Protezione leva in carbonio | LPLITE_R | 270,00 |
| Tank cap - Tappo serbatoio | FC110 | 107,00 |
| Oil cap - Tappo olio | T007 | 35,00 |
| 8ml Oil tank - Serbatoio olio 8ml | 0040 | 60,00 |
| Chain protection - Pinna paracatena | ICP1 | 95,00 |
| Swing arms spools - Supporti cavalletto | 0025 | 29,00 |
| Swing arms spools "racing" - Supporti cavalletto "racing" | 0027 | 33,00 |
| Block mirror - Tappi specchio ('15/'18) | BM02 | 63,00 |



PRICES WITHOUT VAT - PREZZI IVA ESCLUSA

YAMAHA MT-10



DESCRIPTION - DESCRIZIONE

CODE - CODICE

€

| | | |
|-----------------------------------------------------------|----------|--------|
| Rearset - Pedane | Y014 | 483,00 |
| Engine protections - Protezioni motore | CP062 | 445,00 |
| Levers kit - Kit leve | KL250 | 247,00 |
| Lever protection - Paraleva | LPRR | 142,00 |
| Carbon lever protection - Protezione leva in carbonio | LPLITE_R | 270,00 |
| Tank cap - Tappo serbatoio | FC110 | 107,00 |
| Oil cap - Tappo olio | T007 | 35,00 |
| 8ml Oil tank - Serbatoio olio 8ml | 0040 | 60,00 |
| Chain adjuster - Tendicatena | CHAD03 | 249,00 |
| Swing arms spools - Supporti cavalletto | 0025 | 29,00 |
| Swing arms spools "racing" - Supporti cavalletto "racing" | 0027 | 33,00 |



SALES CONDITIONS

All the prices on the brochures are expressed in euro and not comprehensive of VAT tax.

2D®, Aprilia®, BMW®, Braking®, Brembo®, Discacciati®, Ducati®, Honda®, I2M®, Kawasaki®, Ktm®, MV Agusta®, PT®, Suzuki®, Triumph®, Yamaha® are registered trademarks and used for reference.

All Bonamici Racing products are made for agonistic use only.

All Bonamici Racing products are 100% made in Italy, employing high quality materials.

Bonamici Racing reserves the right to change prices and sales conditions at any moment without further notice for commercial and technical purposes. This brochure provides information of general nature and does not represent a contractual binding.

All photos, images and informations displayed in this brochure are property of Bonamici Racing, total or partial reproduction is strictly forbidden.

All Bonamici Racing products have 2 years warranty.

WARNING:

Open the packaging with caution; installation must be operated by specialized personnel with appropriate equipment.

Before use make sure that all screws are tightened with care. Employ "Loctite" adhesive. Do not modify or tamper the parts for any reason. If you have difficulties in assembly, contact the company

CONDIZIONI GENERALI DI VENDITA

I prezzi dei prodotti presenti in catalogo sono in euro e non includono l'IVA.

2D®, Aprilia®, BMW®, Braking®, Brembo®, Discacciati®, Ducati®, Honda®, I2M®, Kawasaki®, Ktm®, MV Agusta®, PT®, Suzuki®, Triumph®, Yamaha® sono marchi di proprietà delle rispettive case ed usati solo a titolo descrittivo.

Tutti i prodotti Bonamici Racing sono da usare esclusivamente per le competizioni.

Tutti i prodotti Bonamici Racing sono realizzati al 100% in Italia con materiali di alta qualità.

Bonamici Racing si riserva il diritto di apportare modifiche costruttive ed ai prezzi dei prodotti presenti nel catalogo in qualunque momento e senza alcun preavviso. Questo catalogo fornisce informazioni di carattere generale e non costituisce documento contrattuale.

Tutte le foto, le immagini e le informazioni presenti in questo catalogo sono proprietà della Bonamici Racing, è vietato l'uso improprio.

Tutti i prodotti Bonamici Racing hanno 2 anni di garanzia.

AVVERTENZE:

Aprire la confezione con cura, il montaggio deve essere eseguito da personale specializzato con attrezzatura adeguata.

Prima dell'uso assicurarsi che tutte le viti siano tirate con cura. Usare la Loctite.

Non modificare o manomettere per alcun motivo le parti.

Se si riscontrano difficoltà nel montaggio contattare l'azienda.



Bonamici Racing S.r.l.

info@bonamiciracing.it
sales@bonamiciracing.it
www.bonamiciracing.it
tel. +39.0744.71.91.32

Headquarters - Sede operativa:

Strada Flaminia sn. civ.
Z.I. Molette di Otricoli
05030 Otricoli (TR)
Italy

Registered office - Sede amministrativa:

Vocabolo Verzieri , snc
02046 Magliano Sabina (RI)
Italy



www.bonamiciracing.it